

# T-7 elewacja

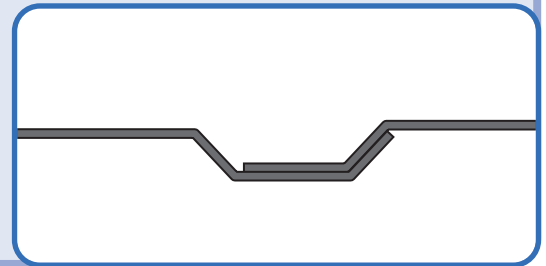

# T-7 PRO

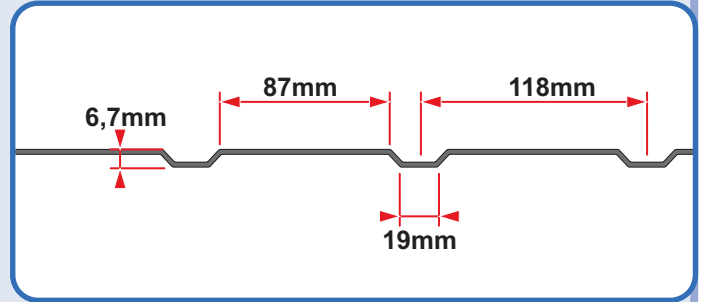
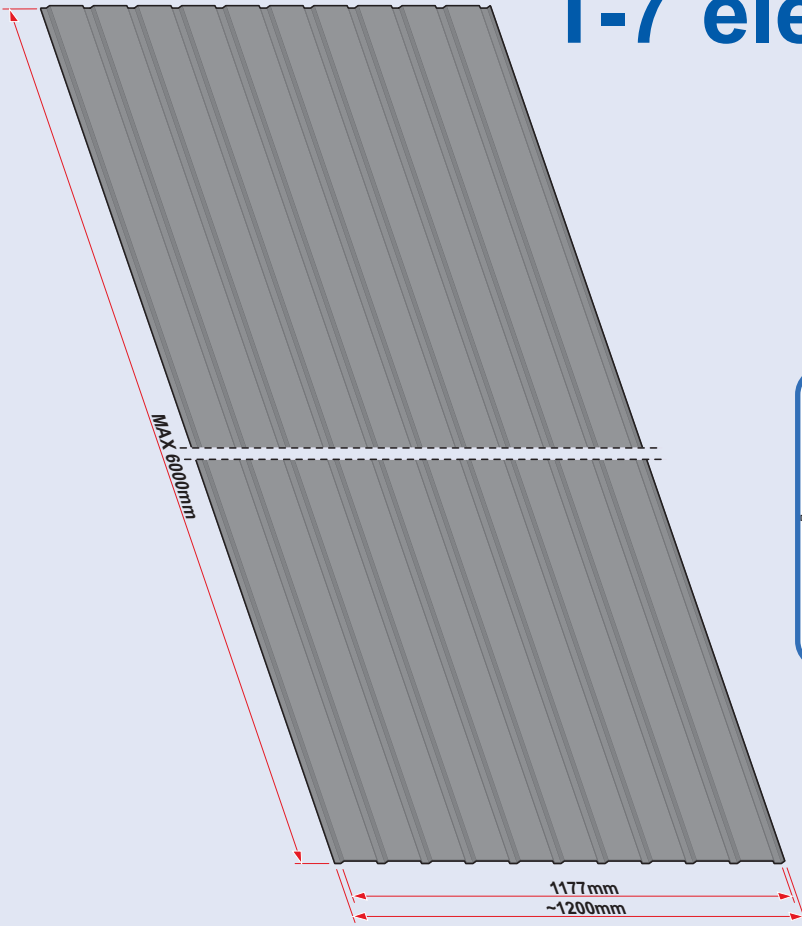
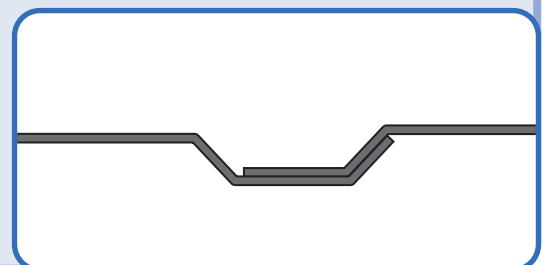
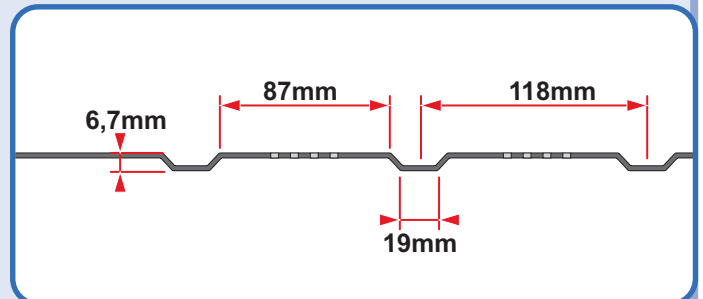
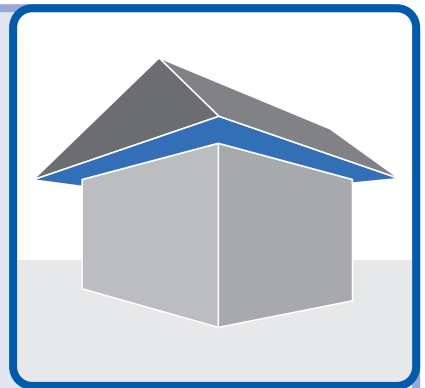
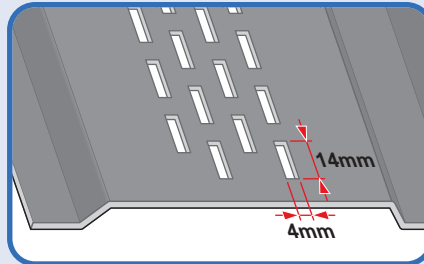
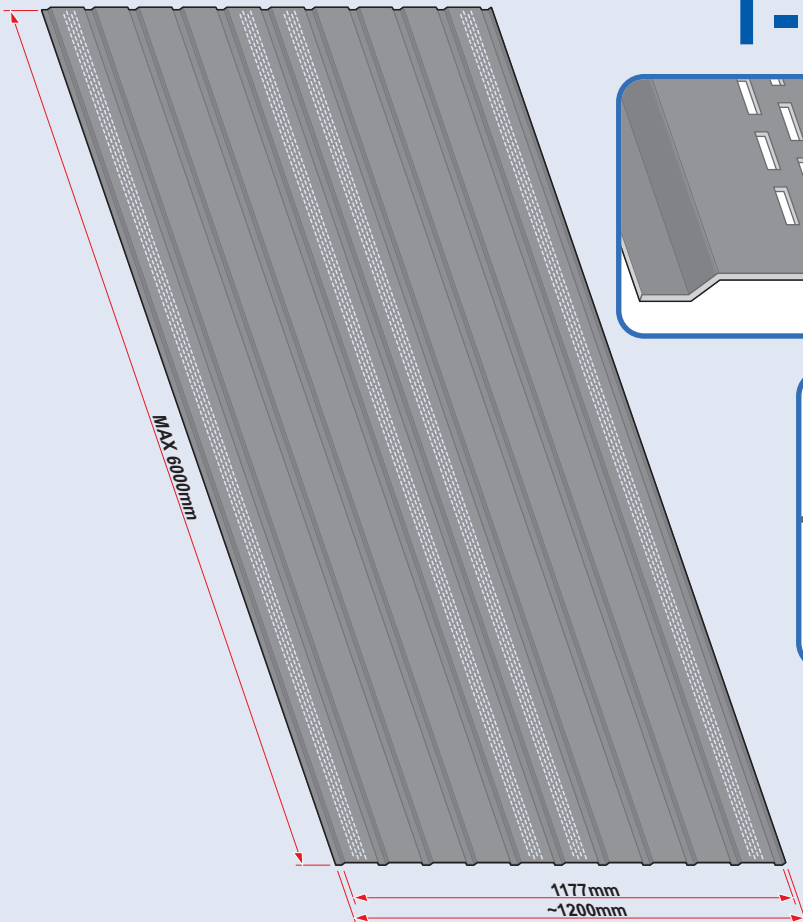

**Sugerowane przykładowe wymiary!**

1

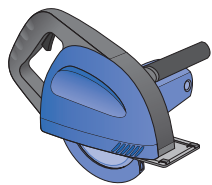
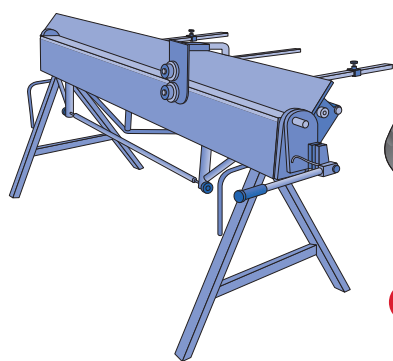

max 4000 r/min

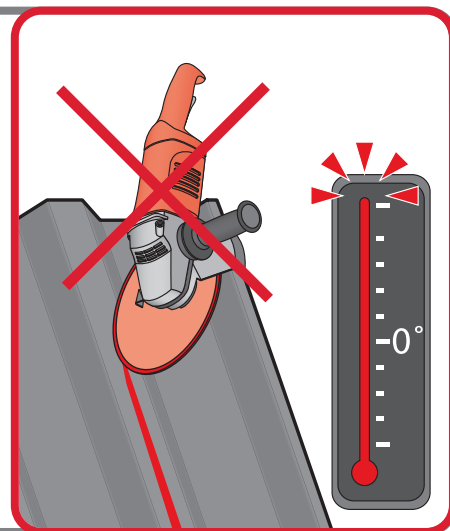
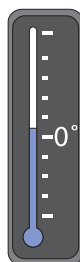
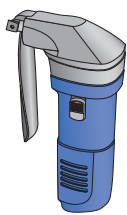

2

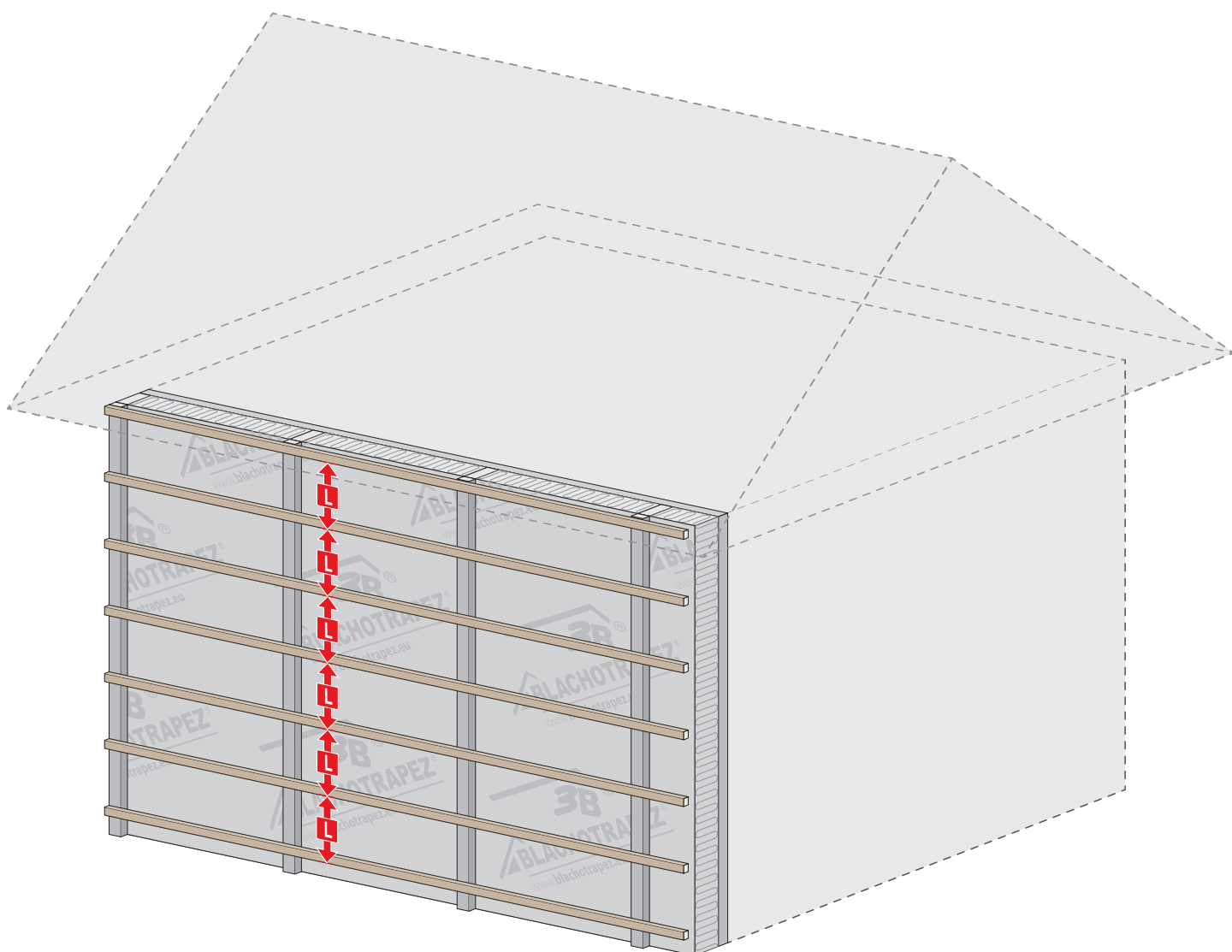

Odległość (L) wd projekcie. Zależy do rodzaju konstrukcji, grubości rdzenia, długości arkuszy, regionu.

3a

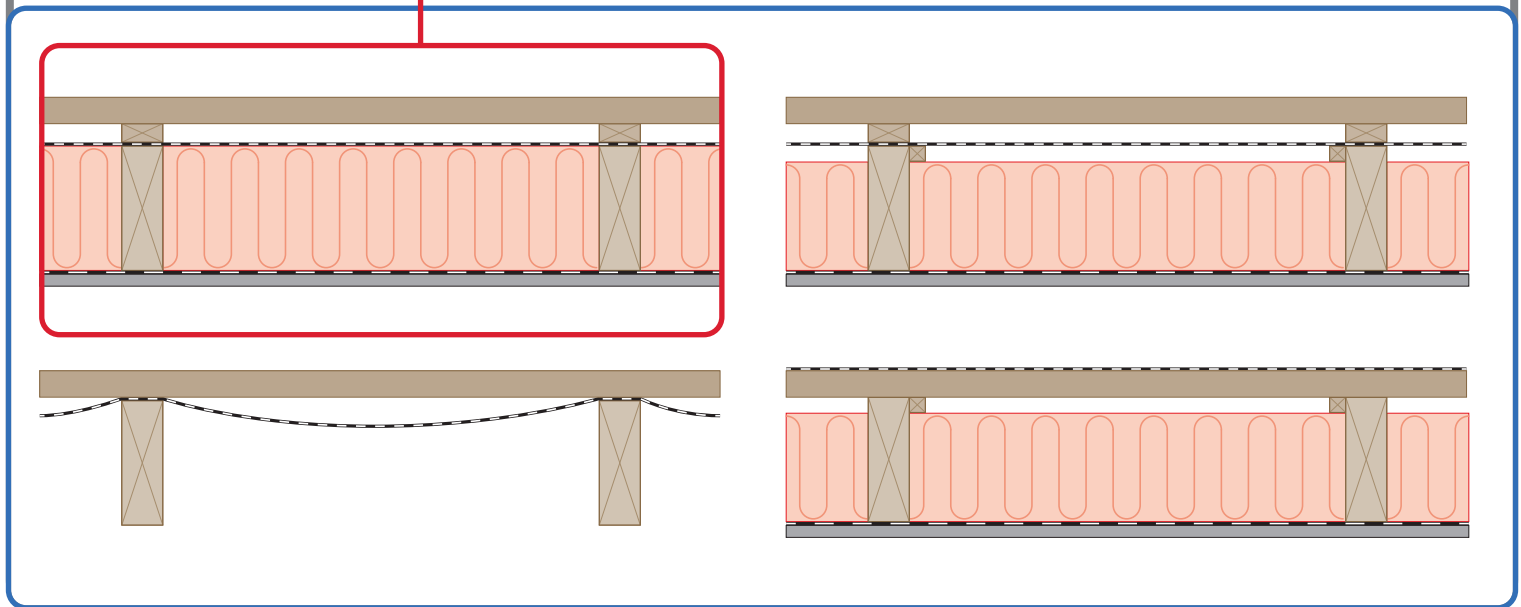
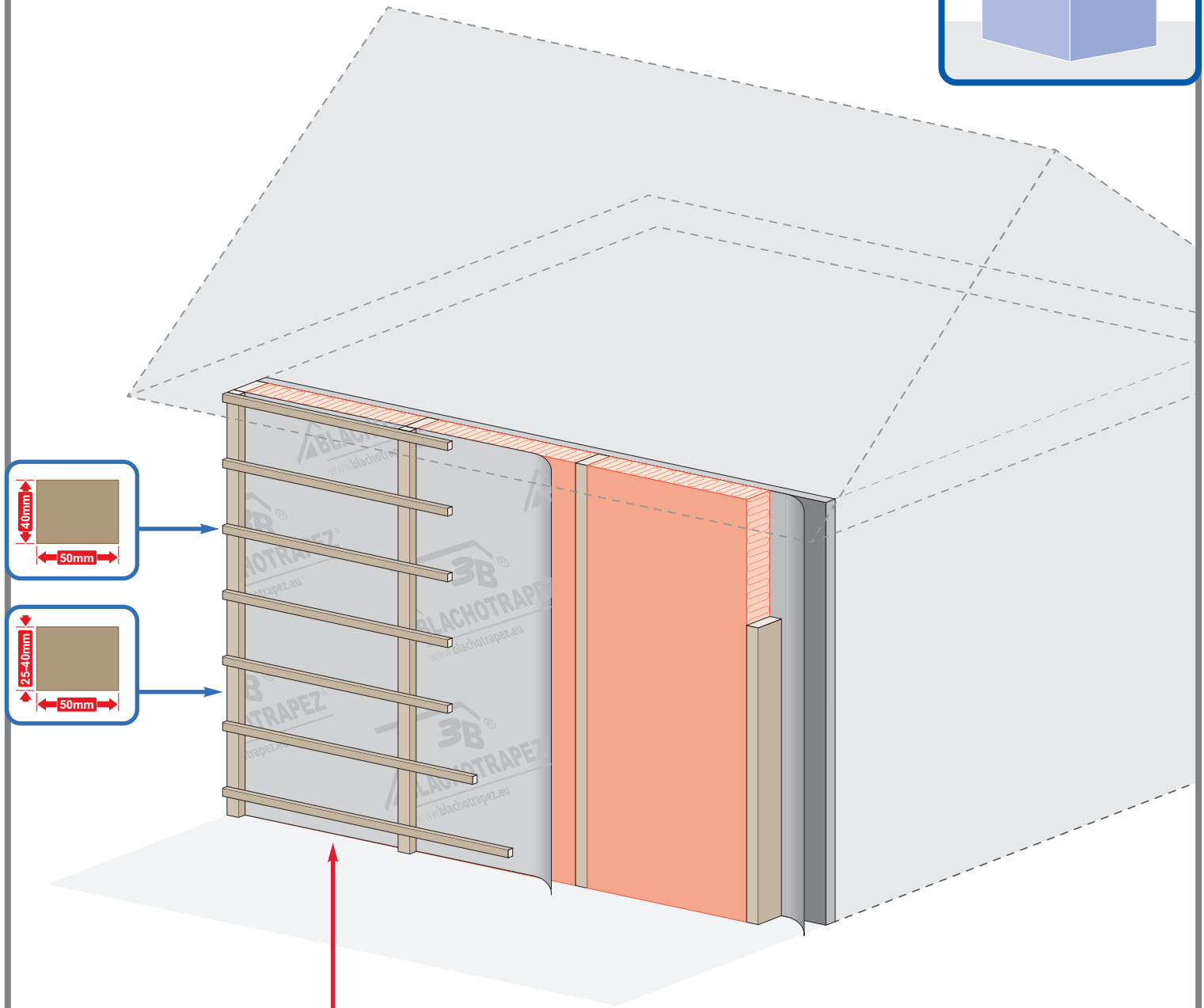
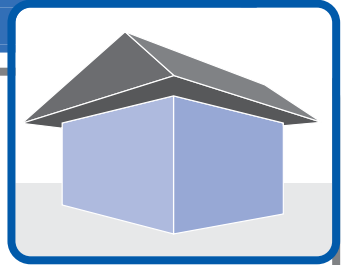

3b

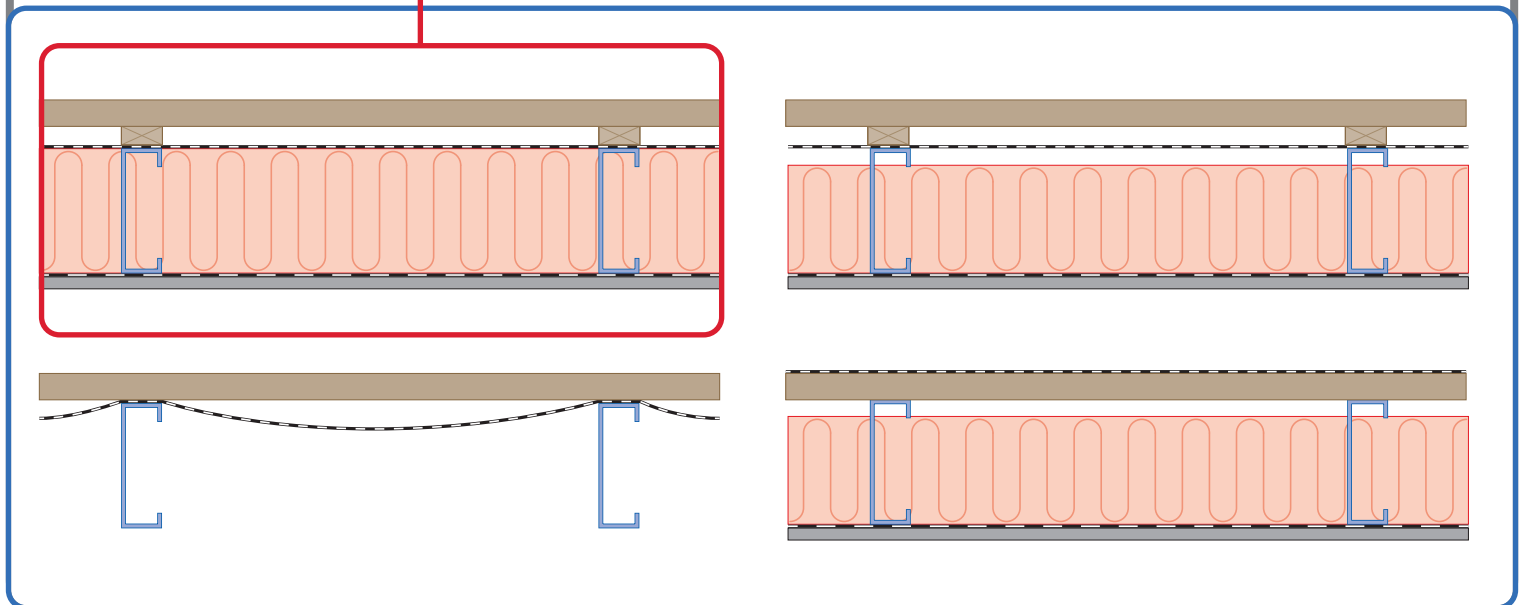
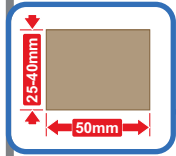
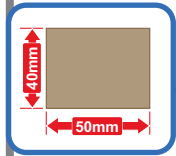
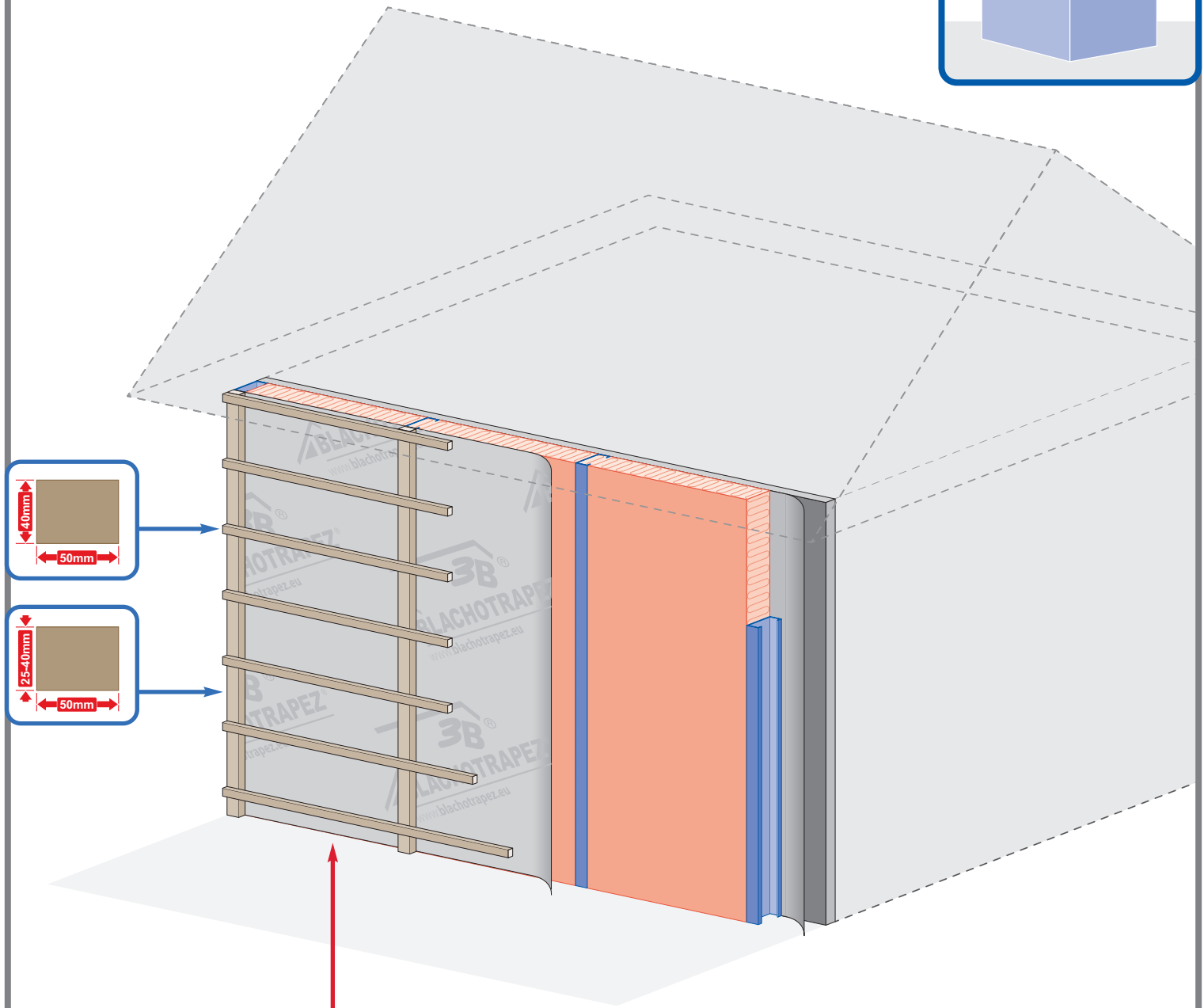
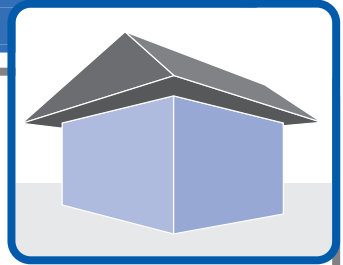

3c

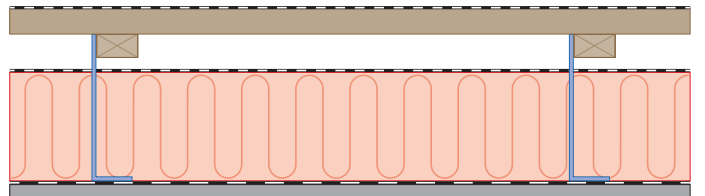
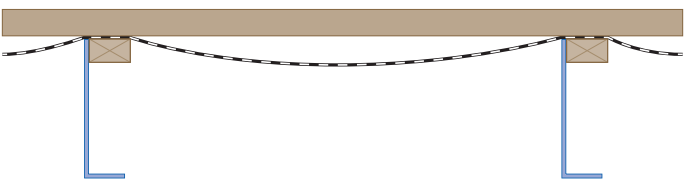
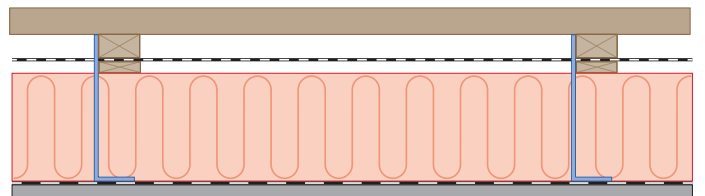
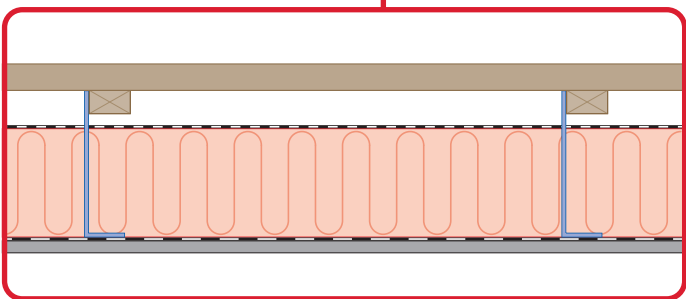
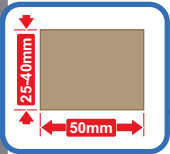
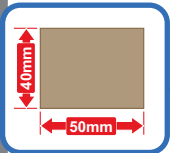
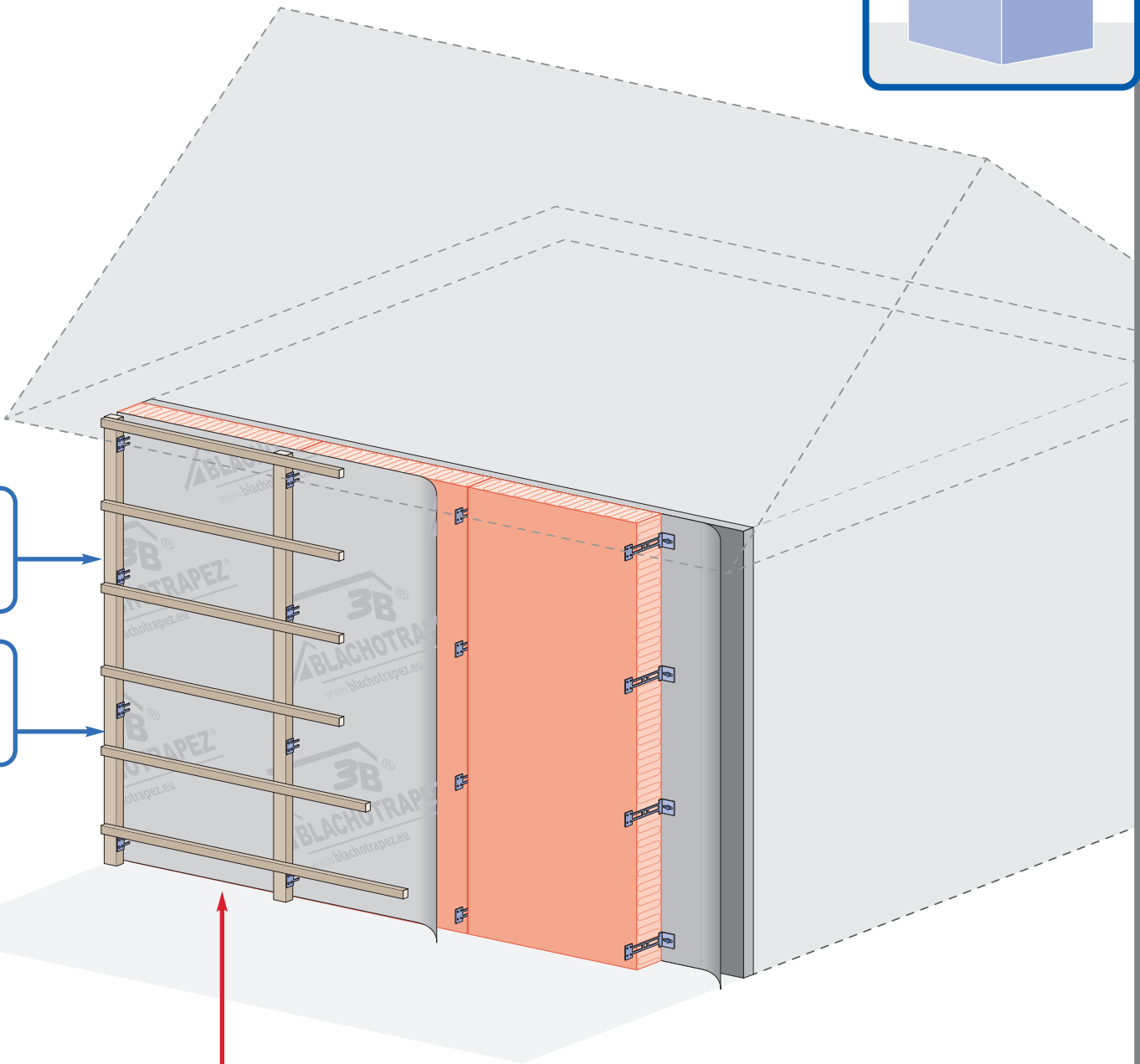
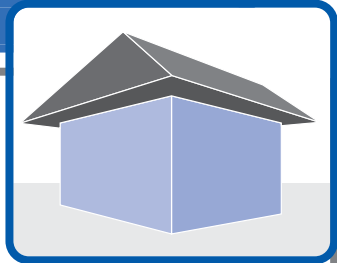

4a

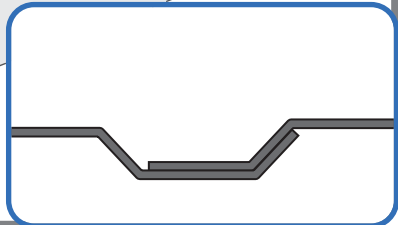
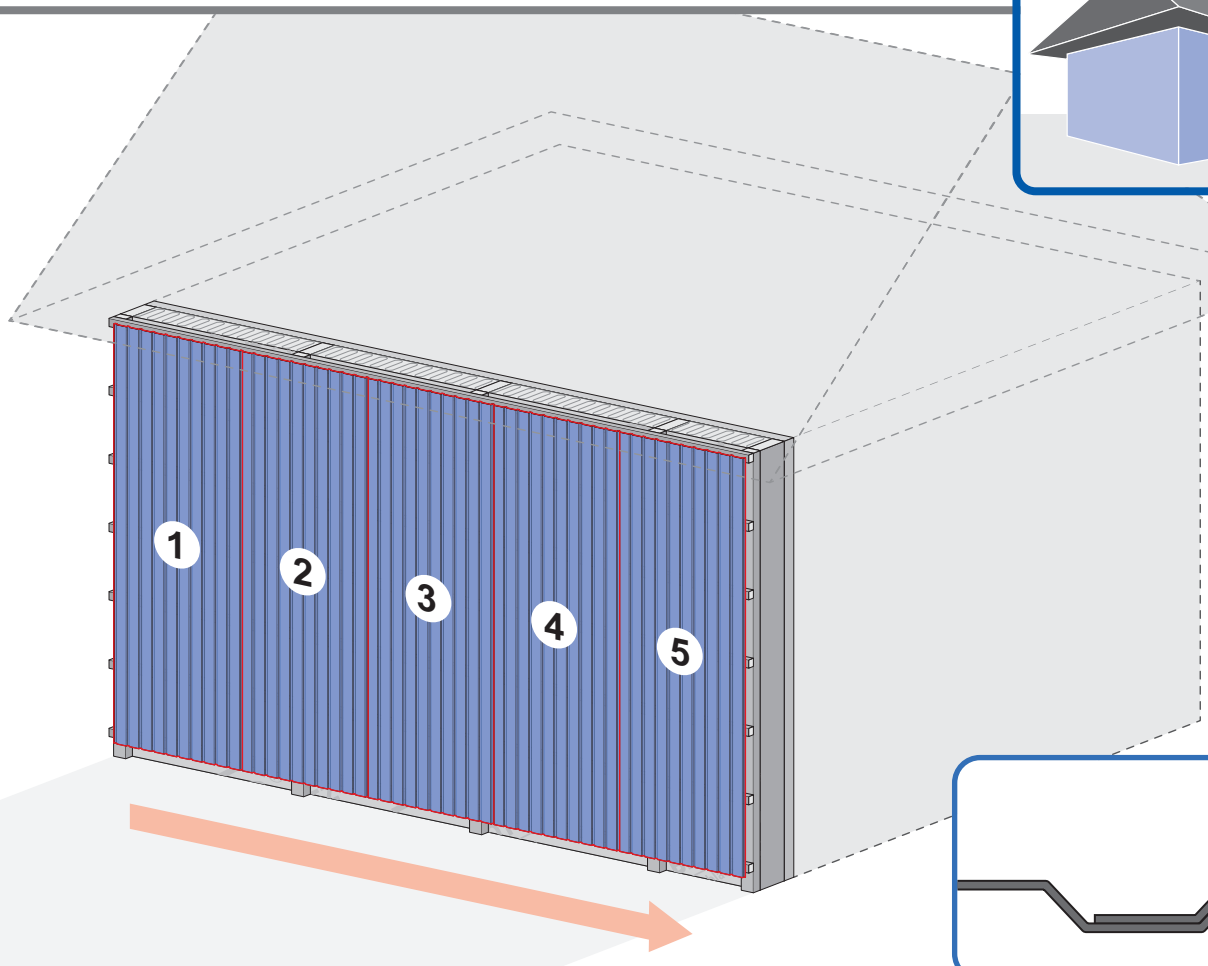
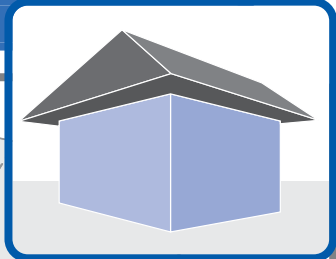

4b

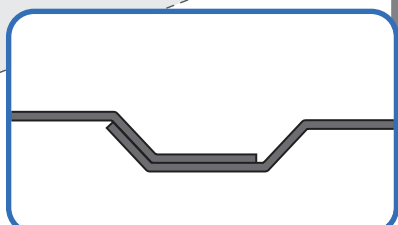
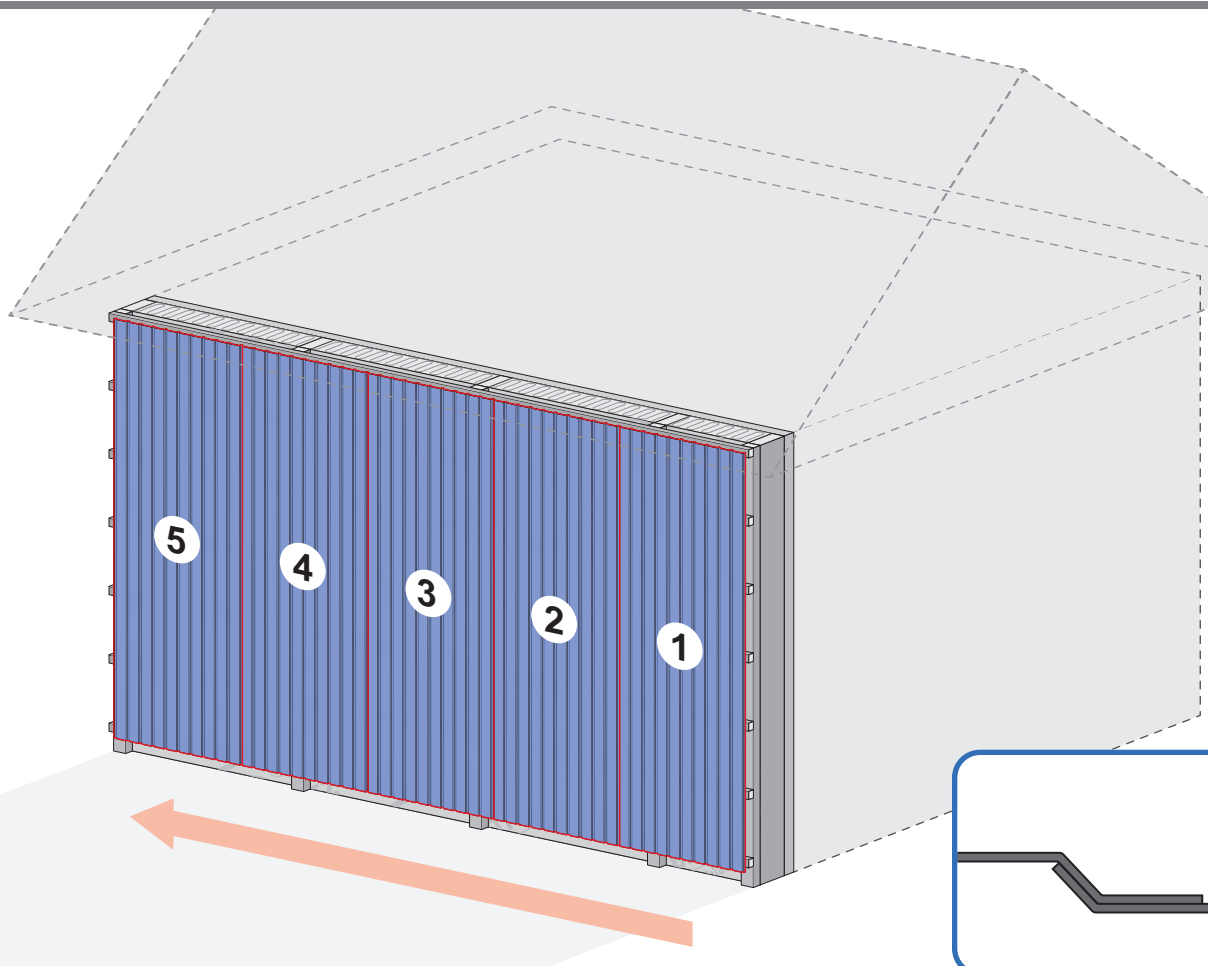



4c

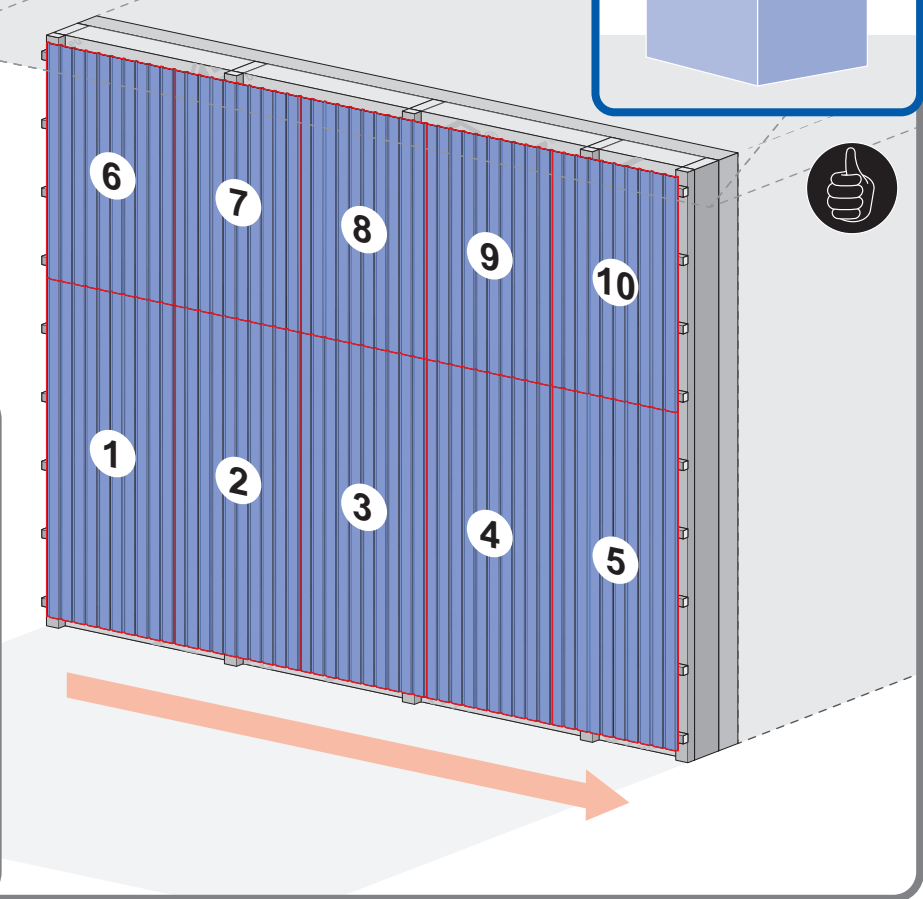
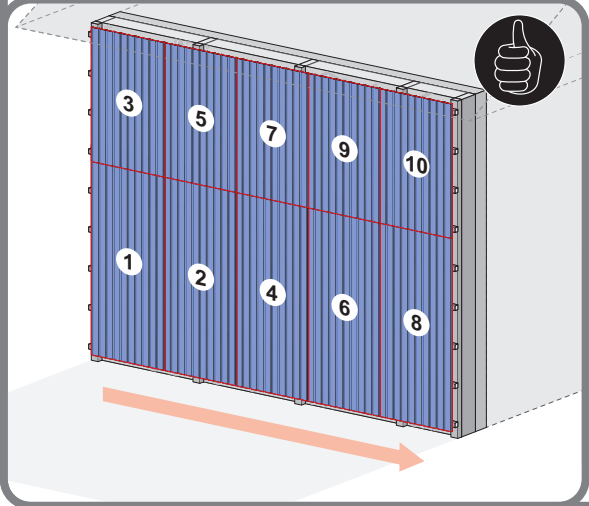
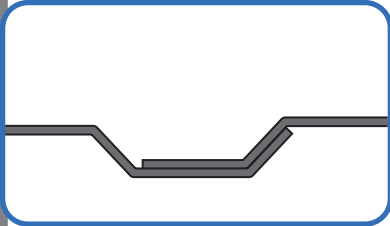
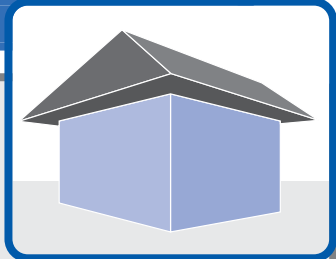

4d

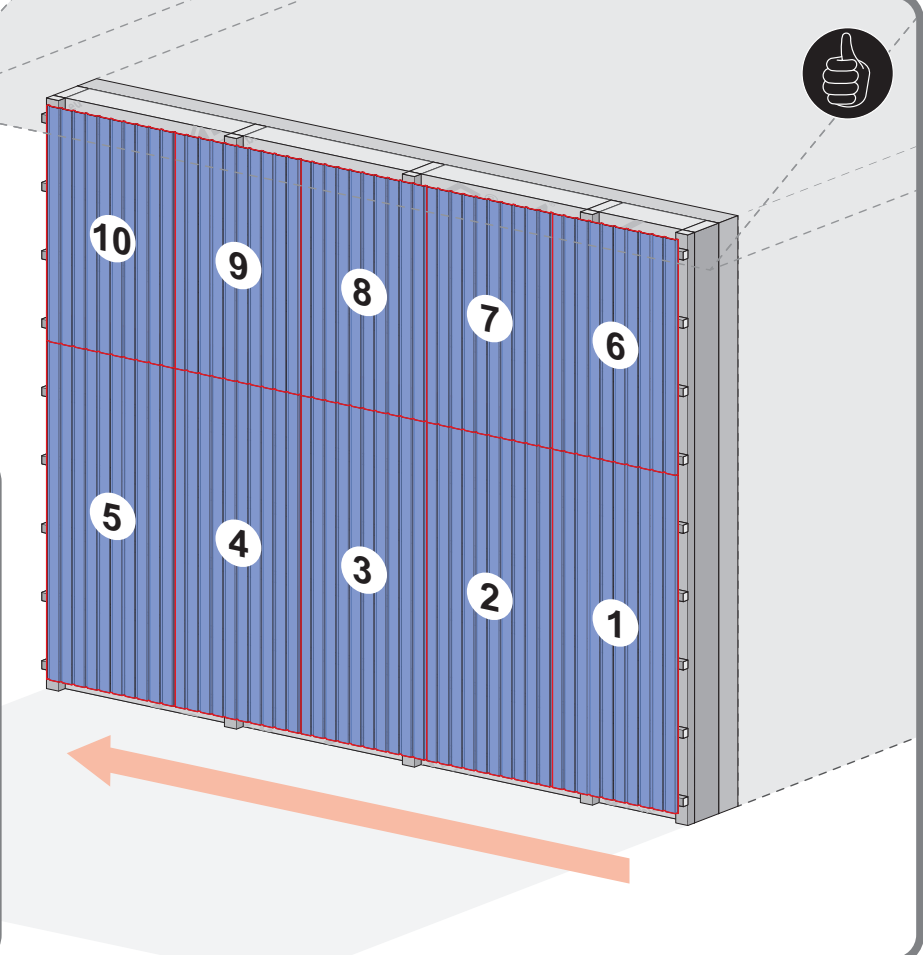
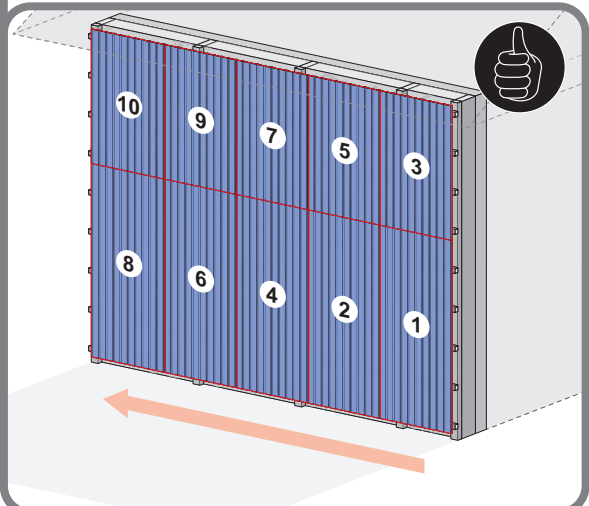
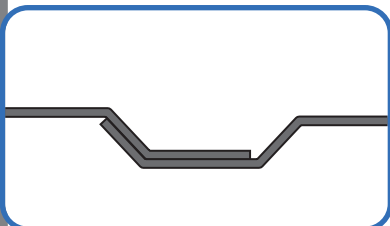

5a

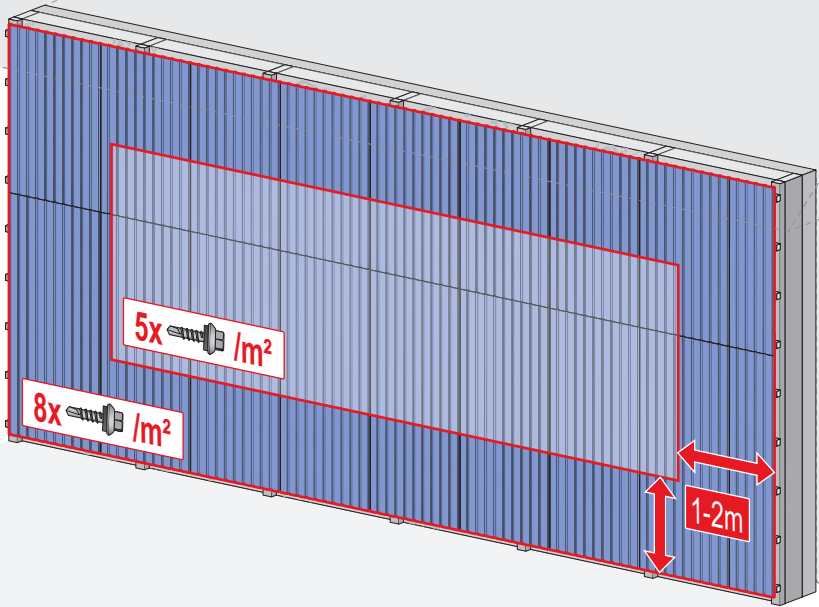
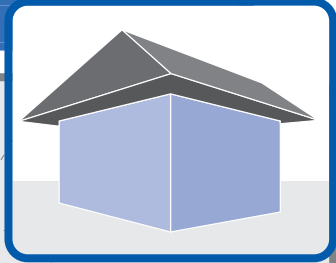

5b

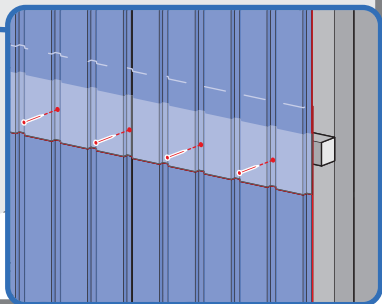
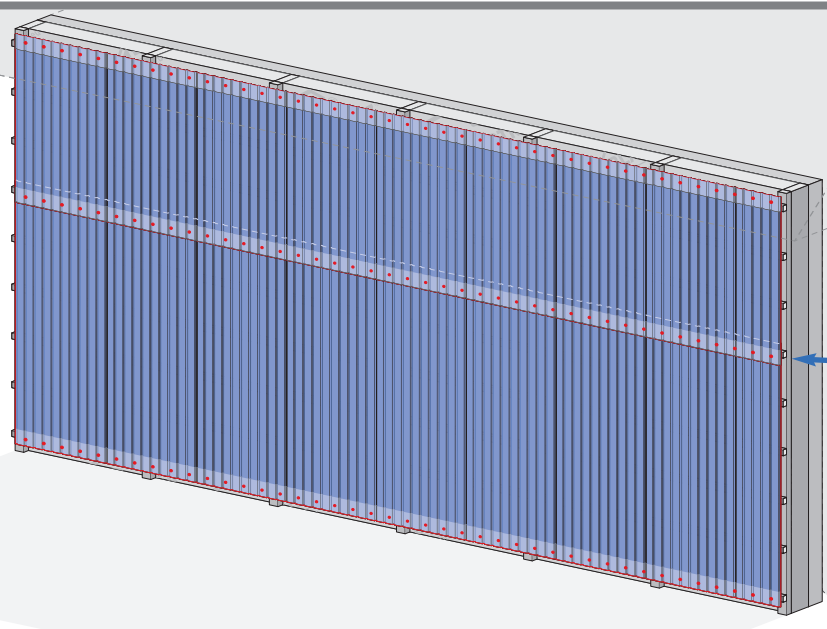

5c

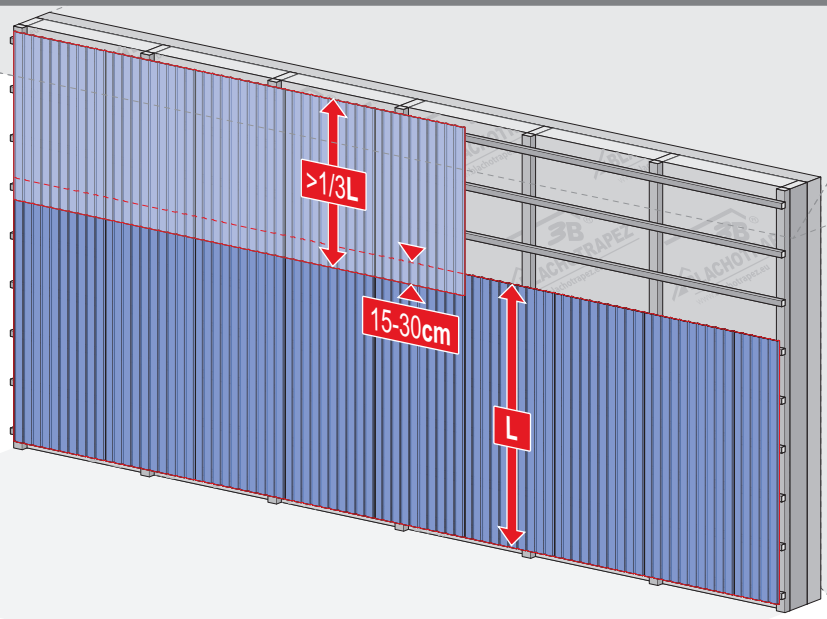

6a

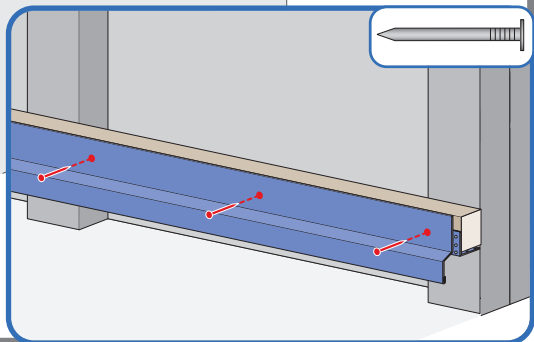
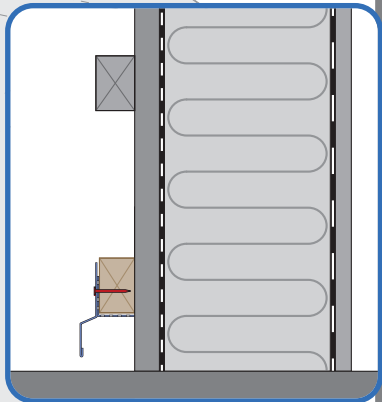
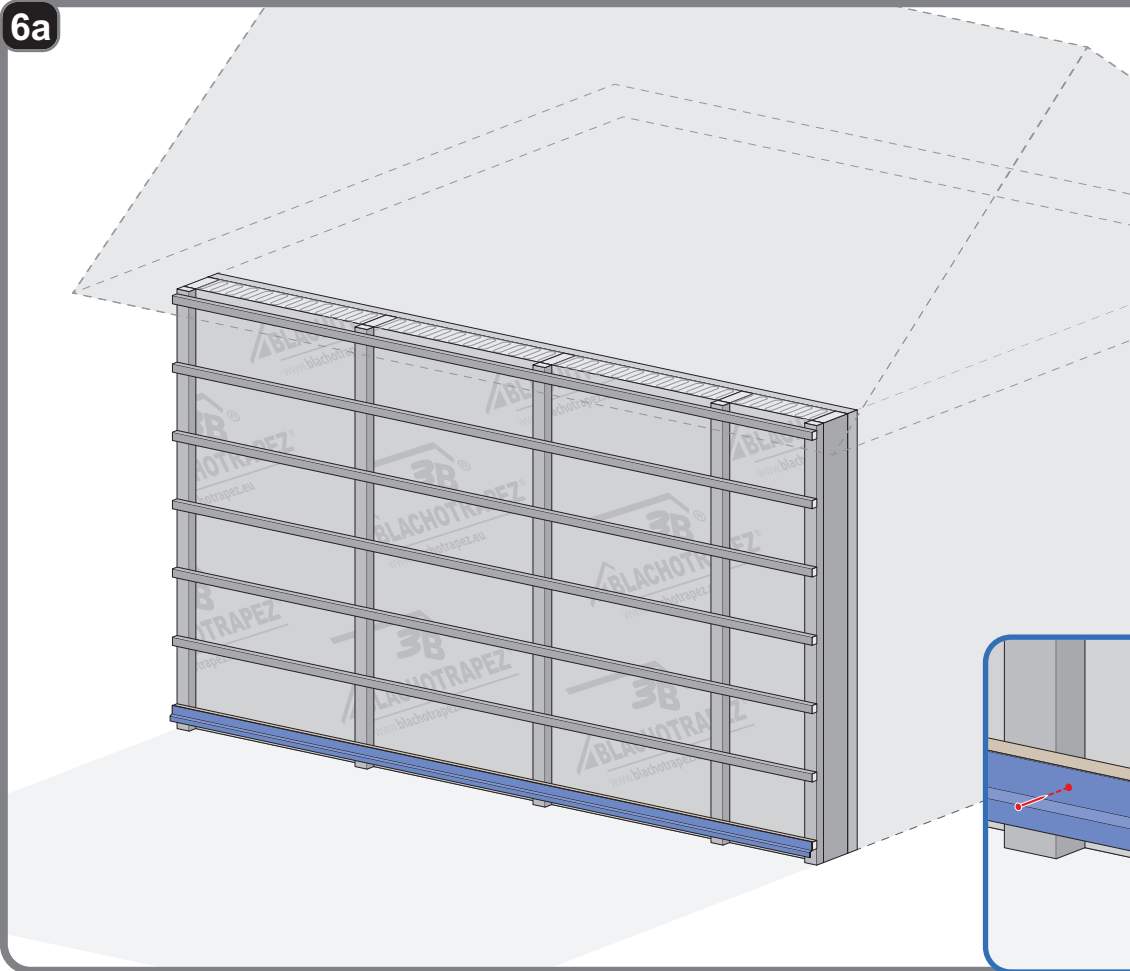
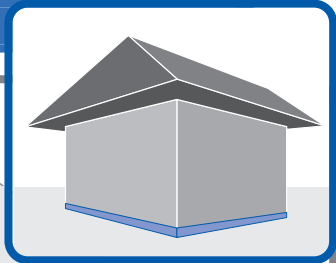

6b

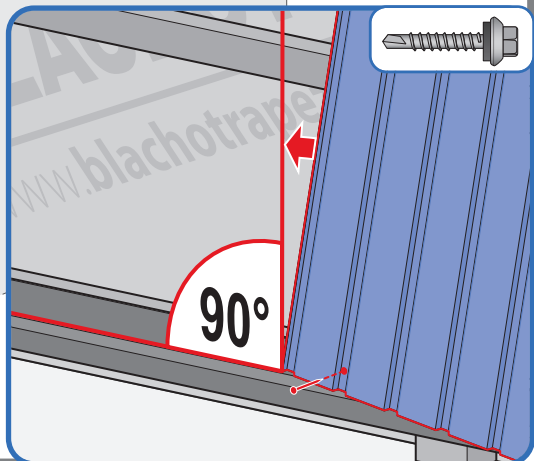
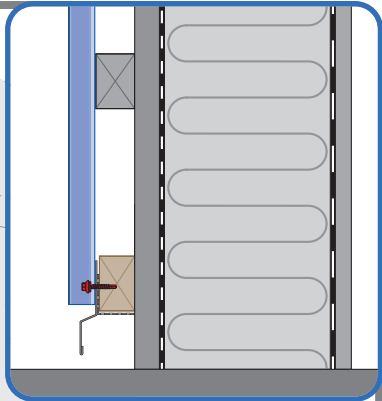
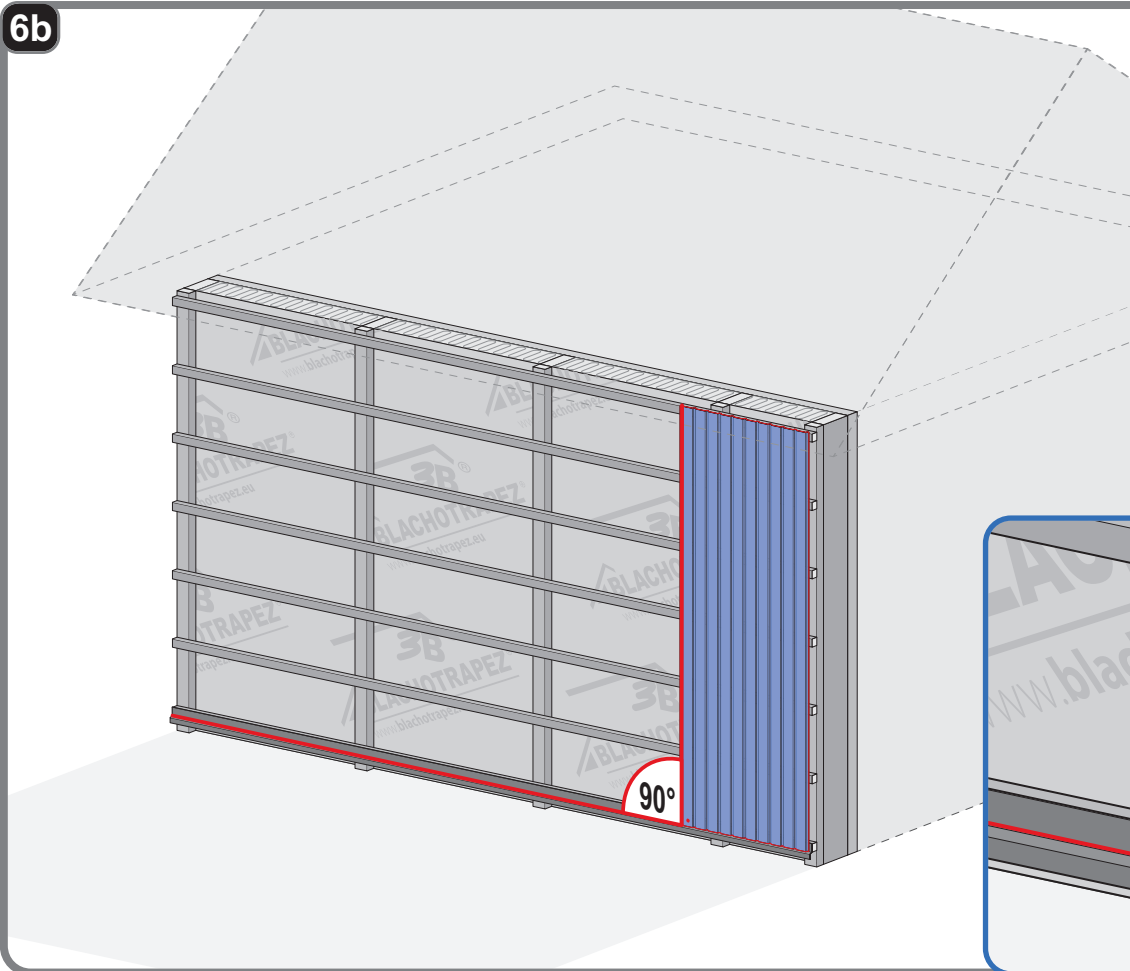

6c

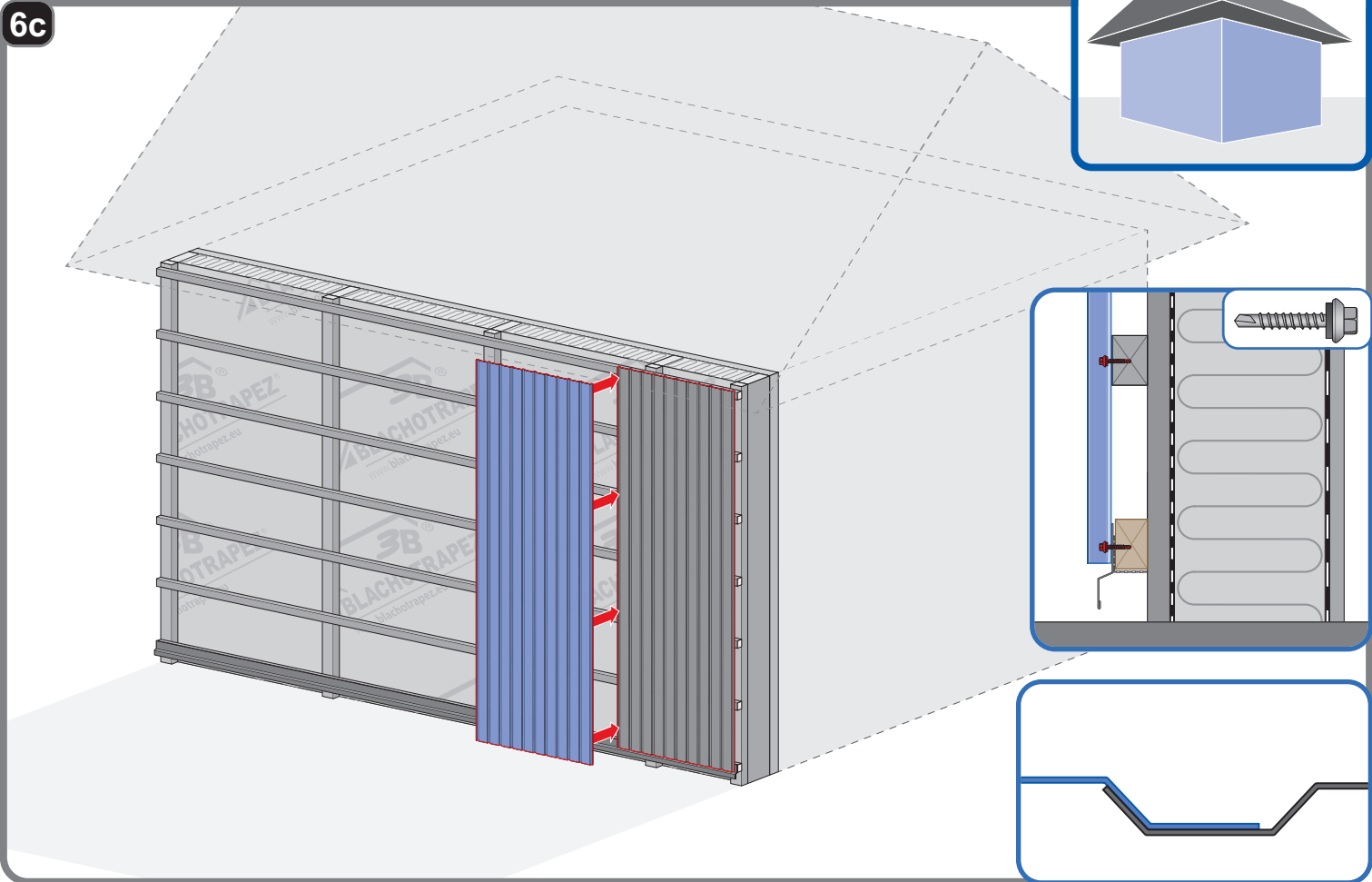
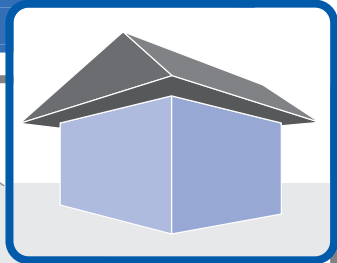

6d

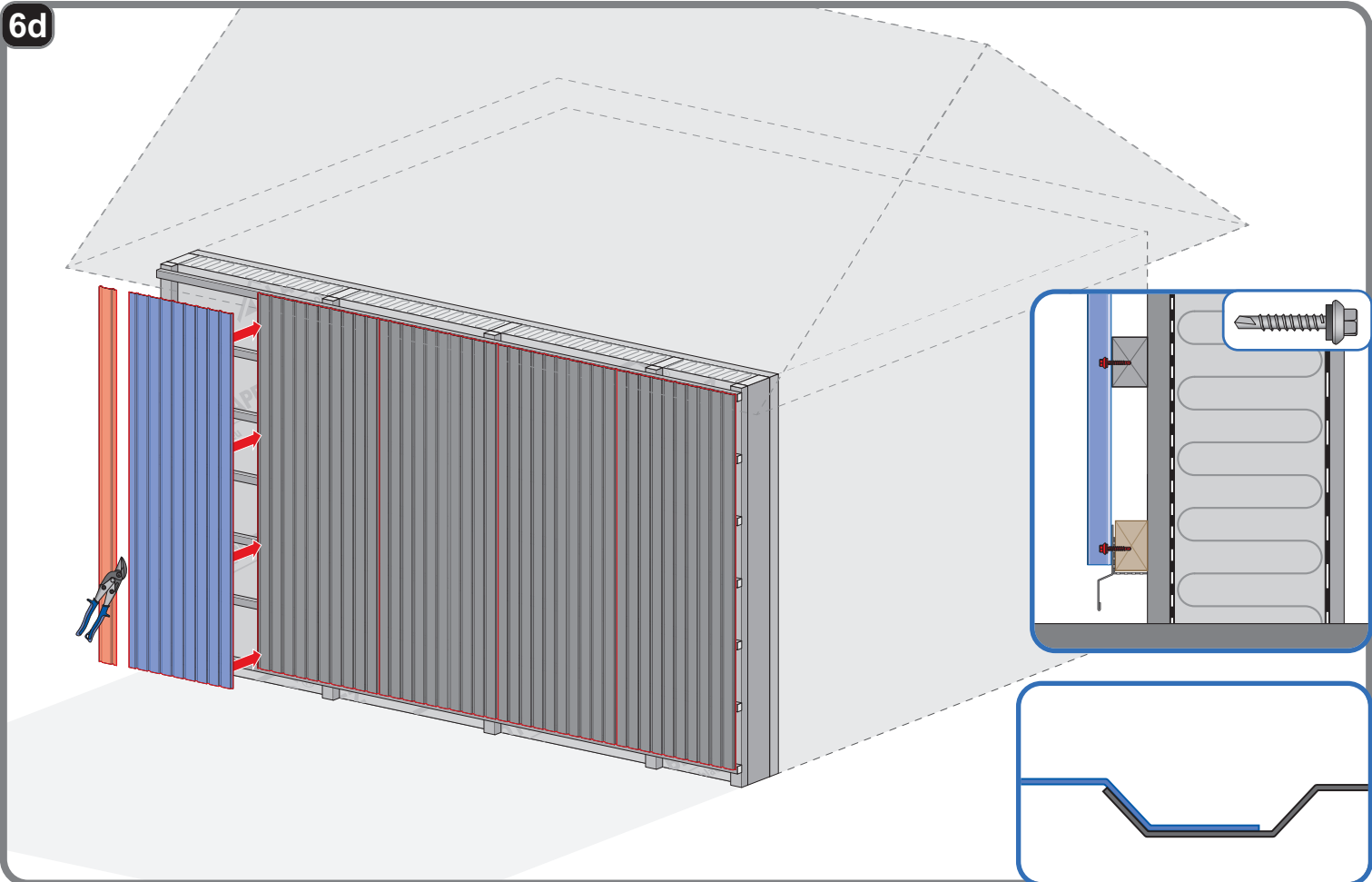

7a

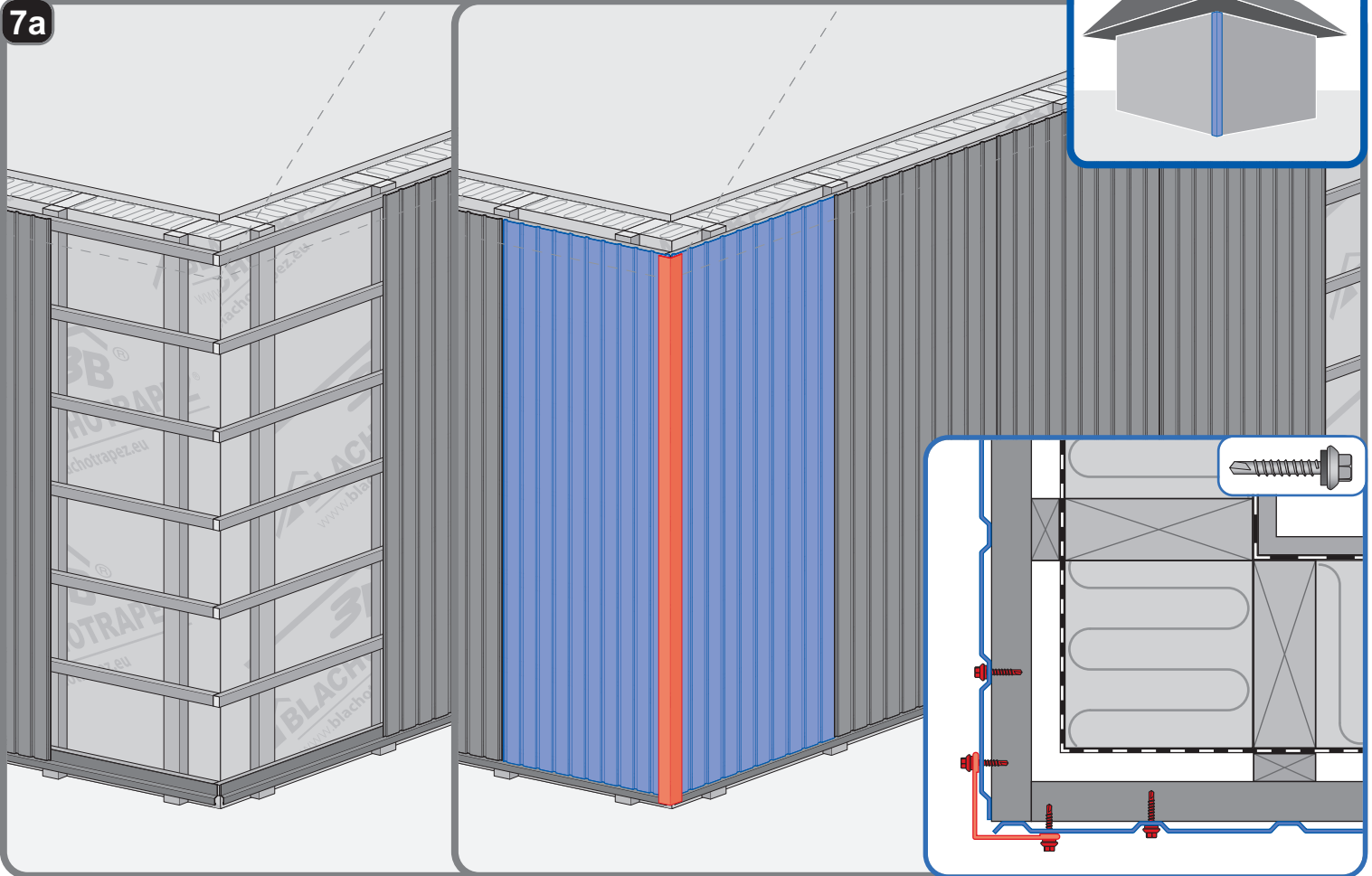

7b

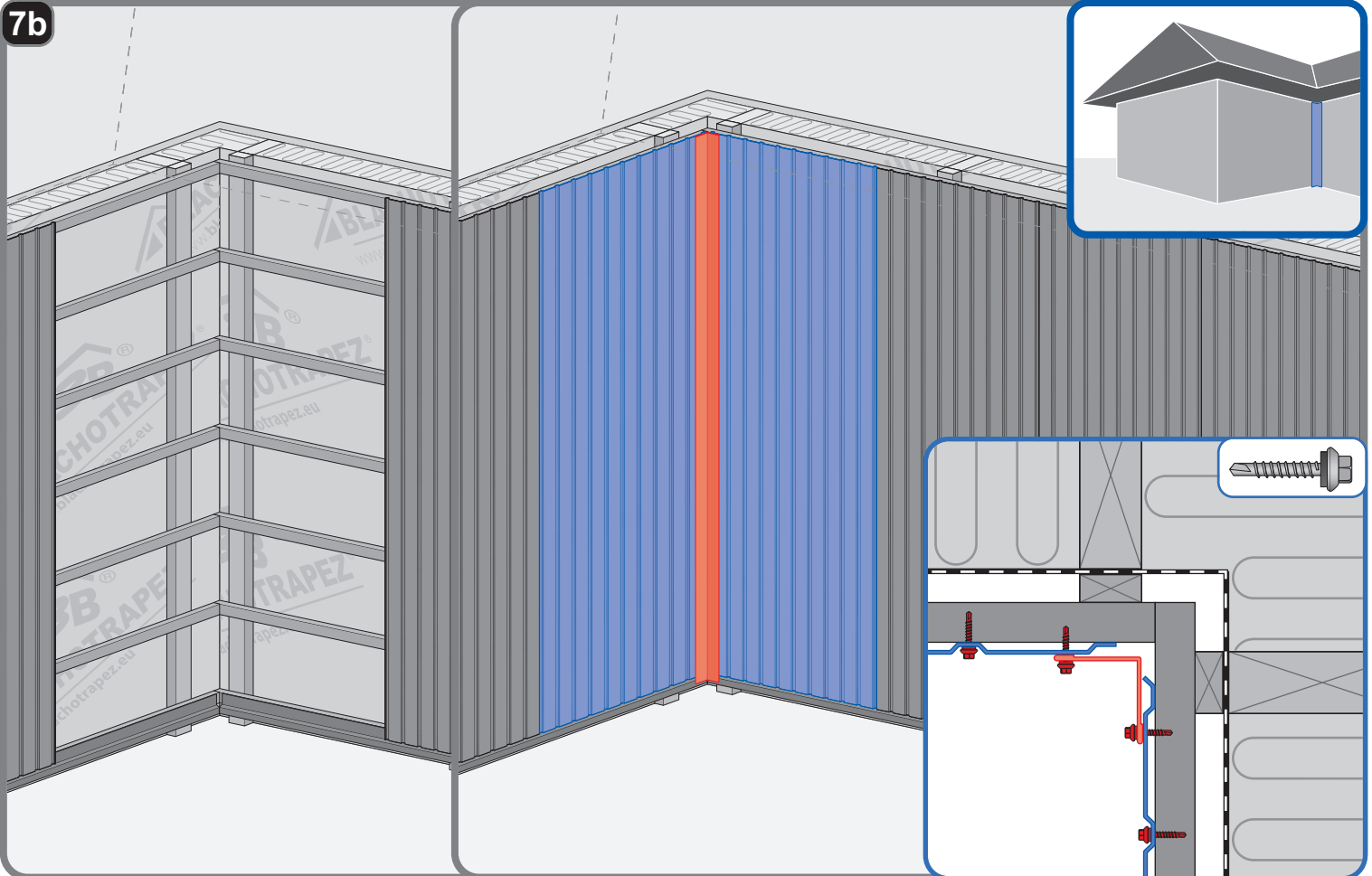

8a

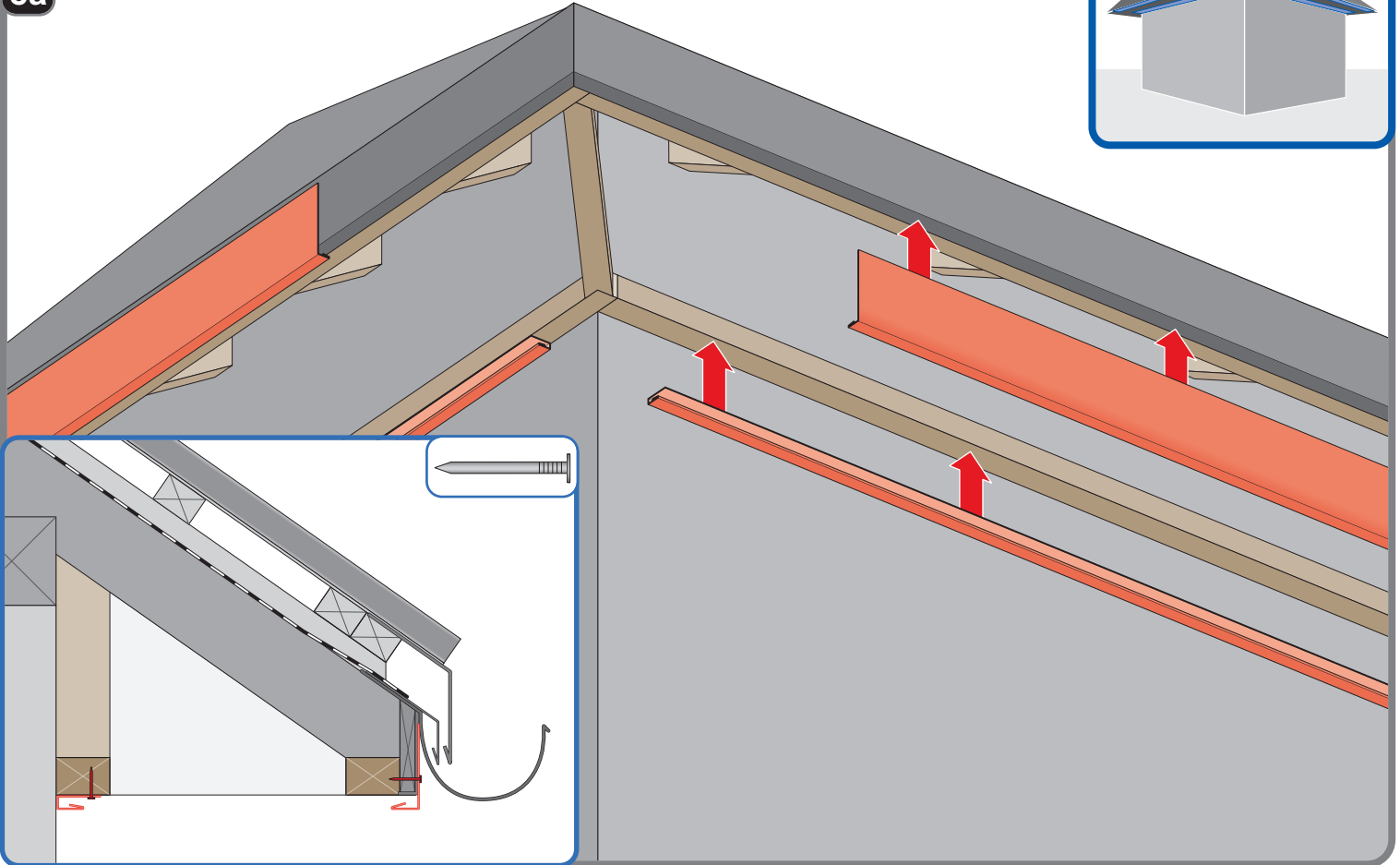
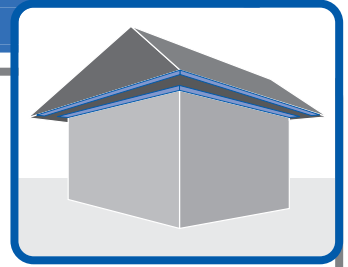

8b

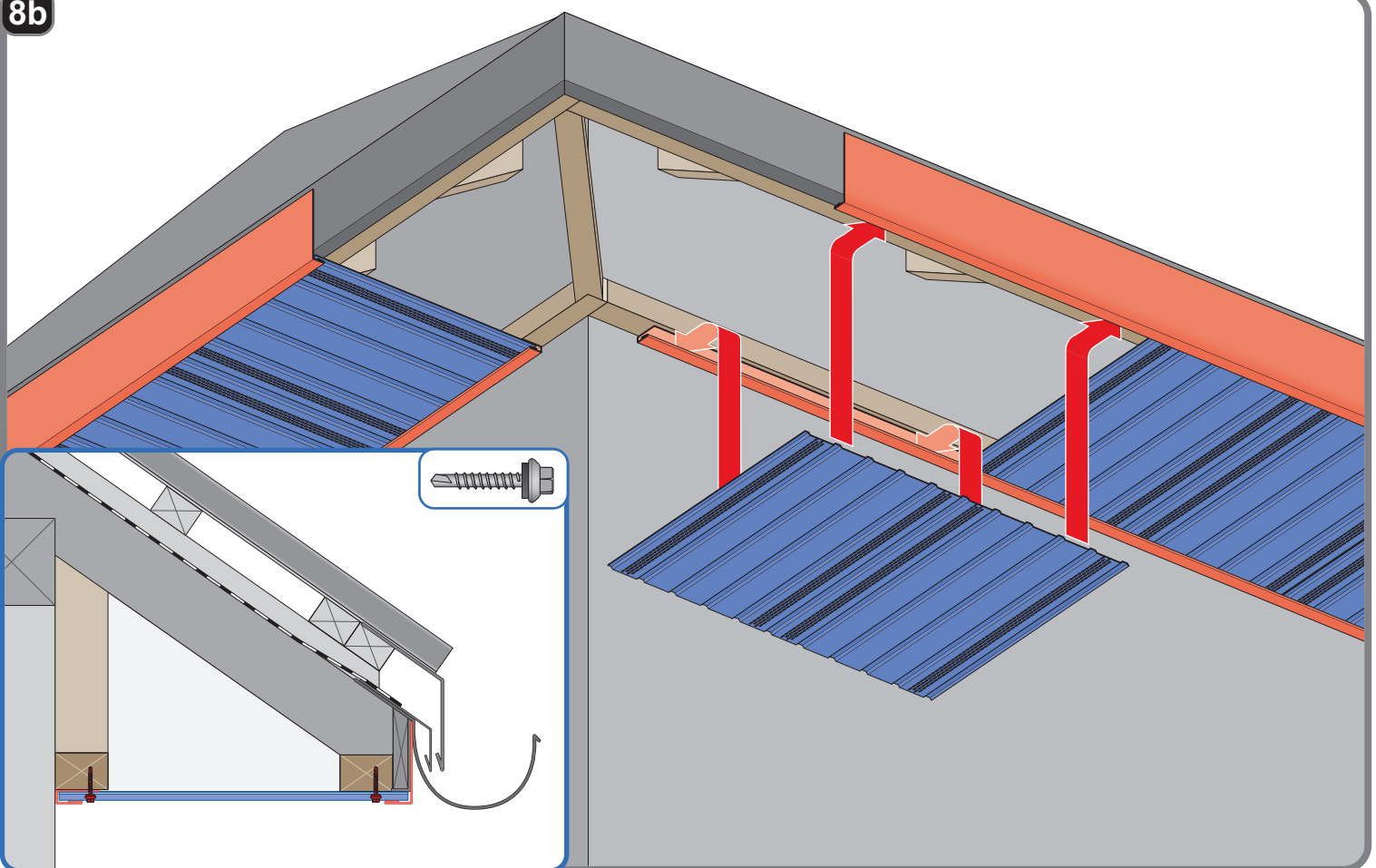

8c

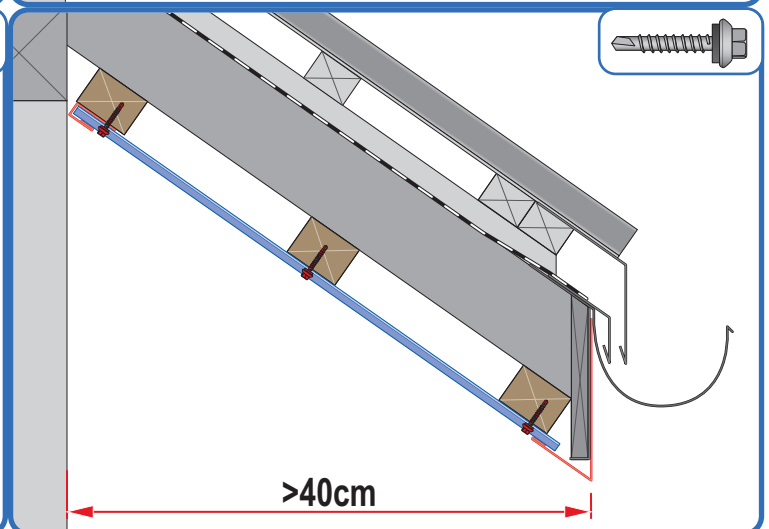
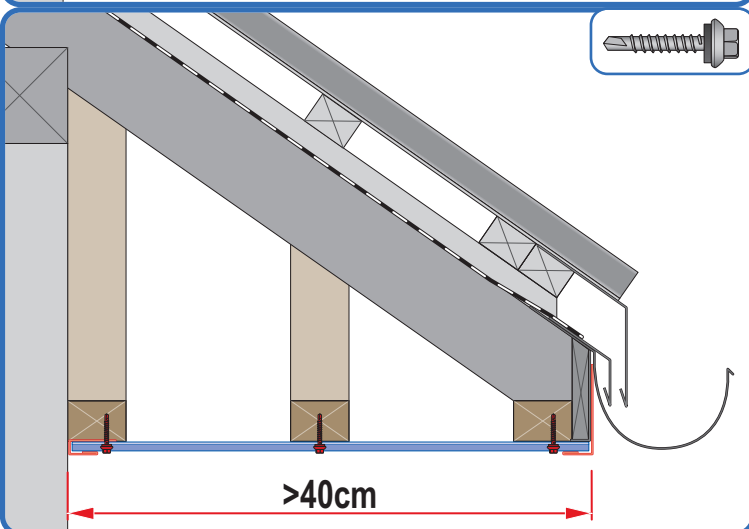
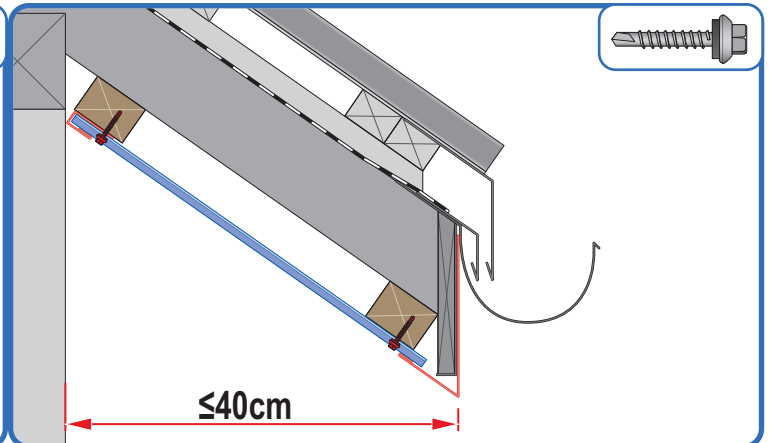
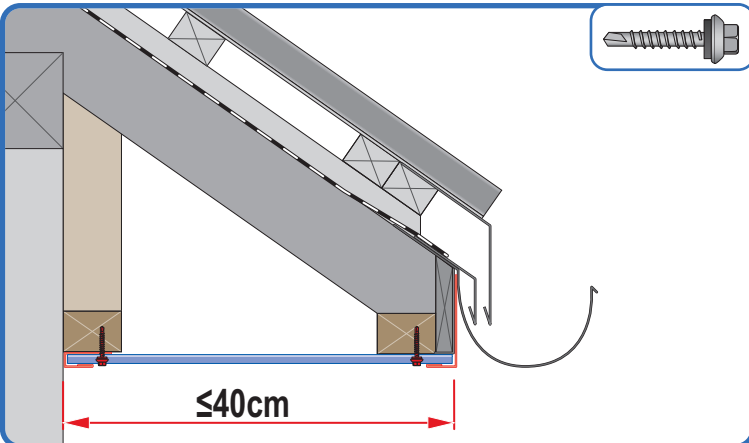
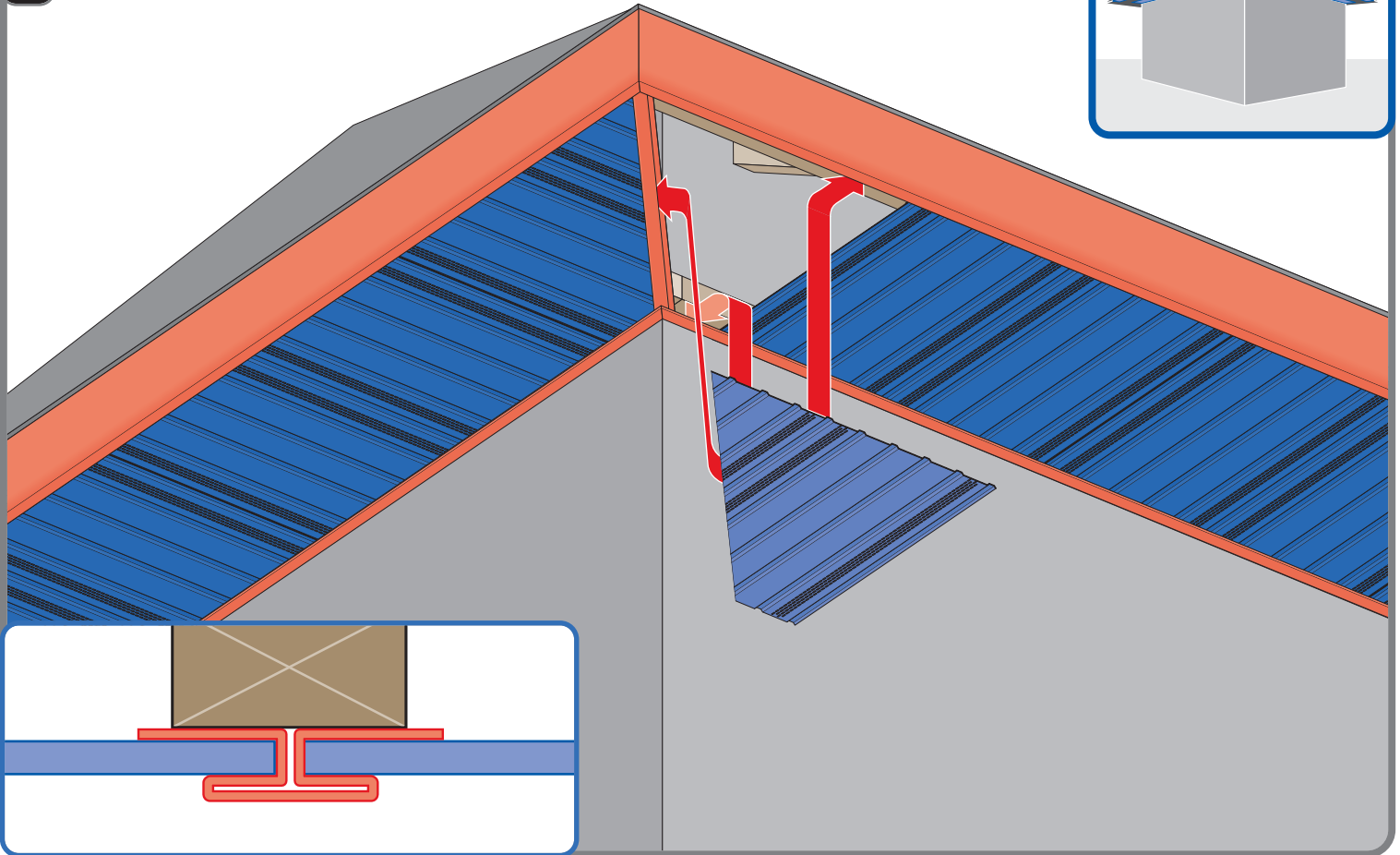
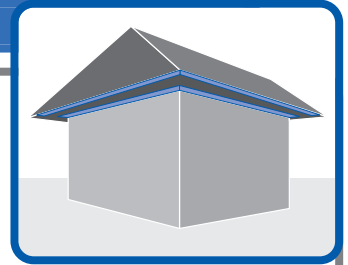

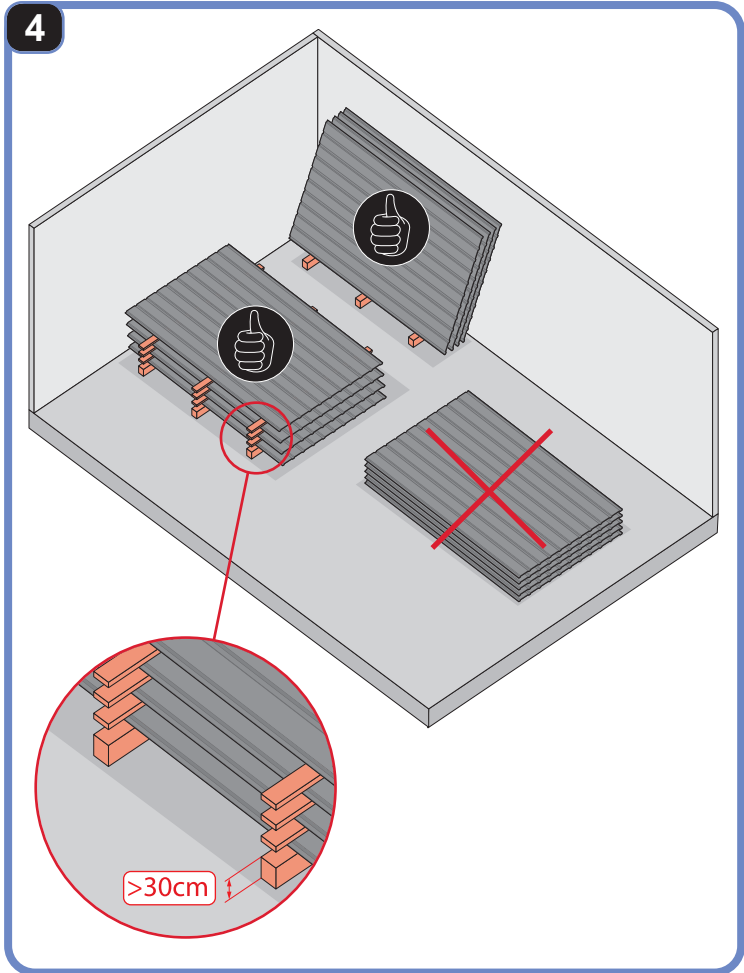
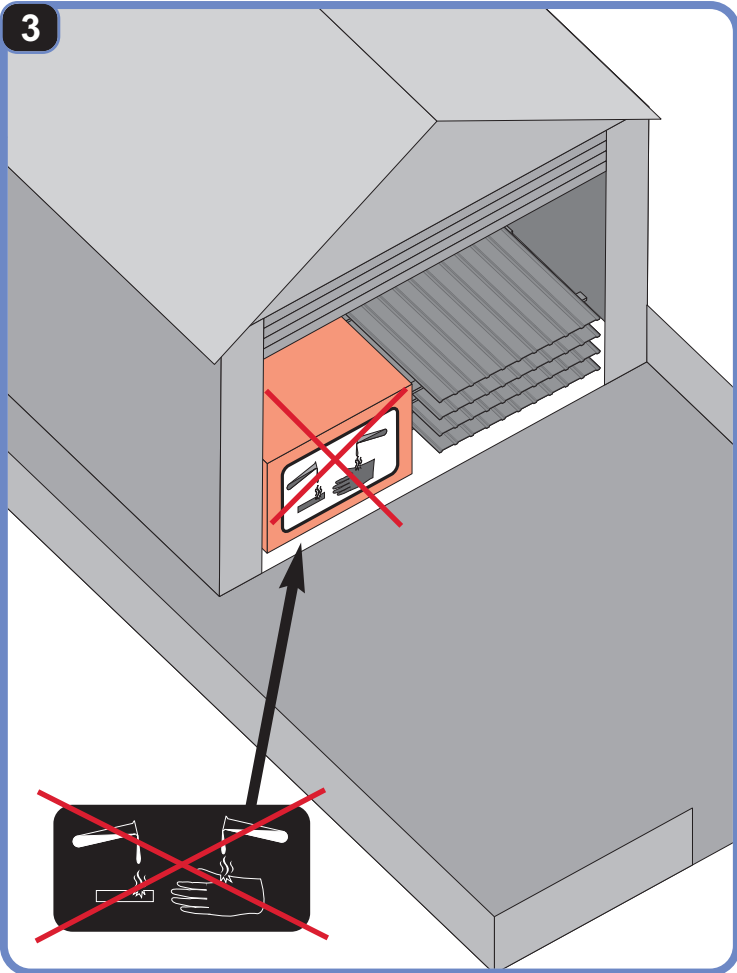
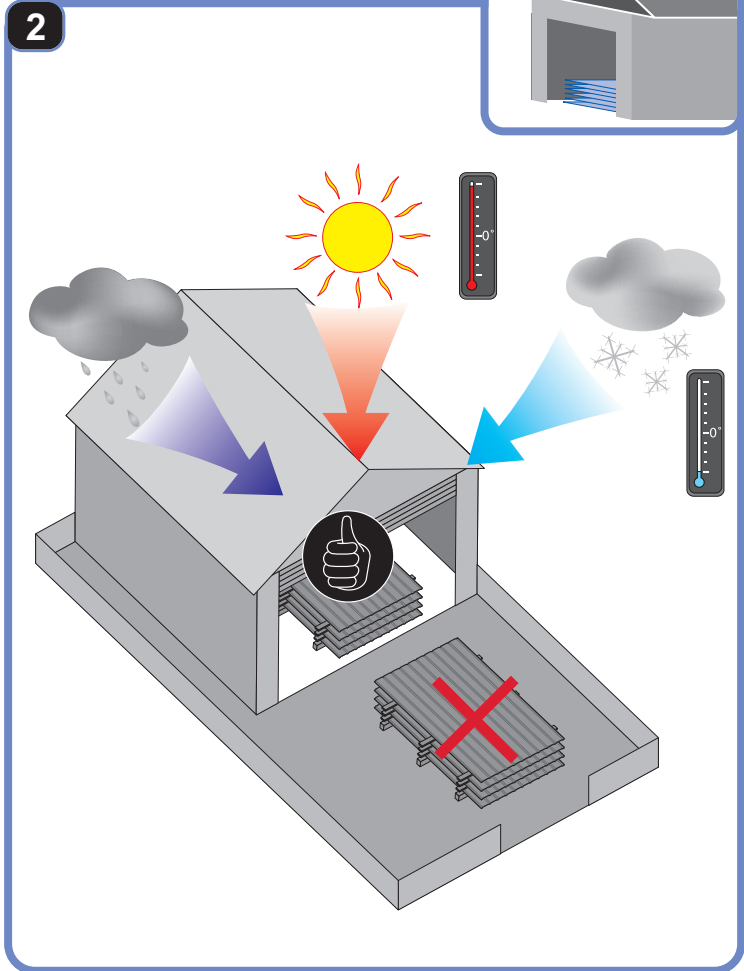
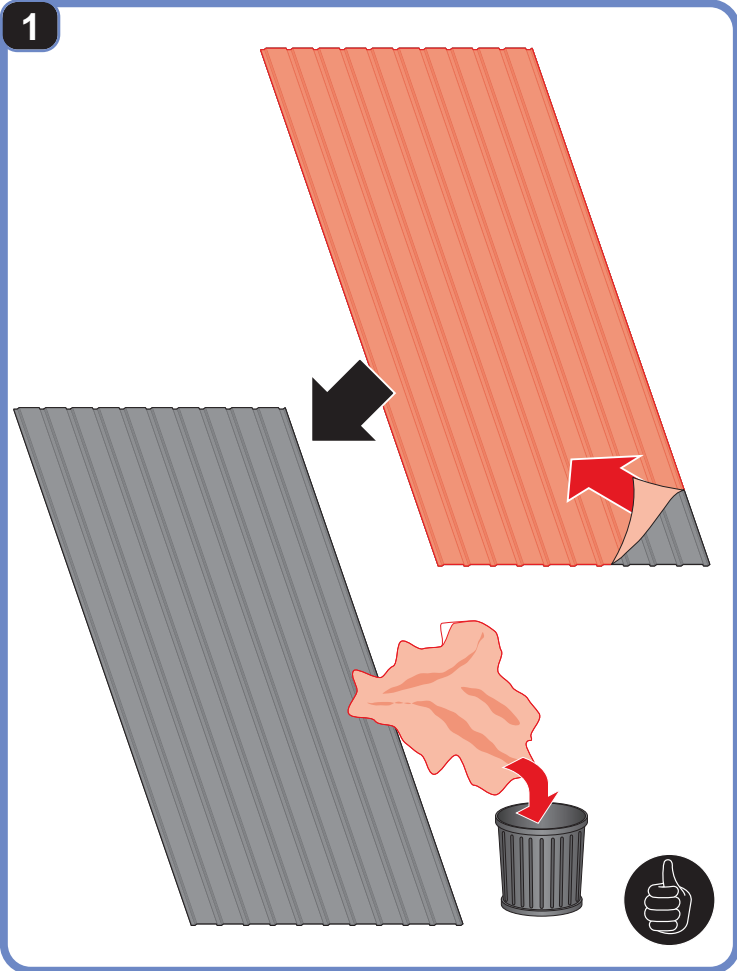



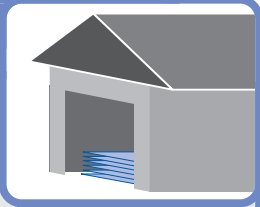

5

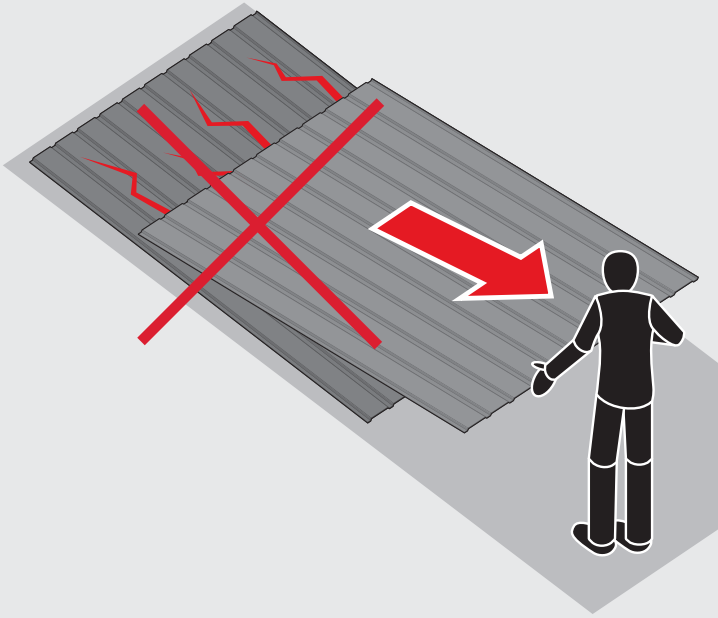

6

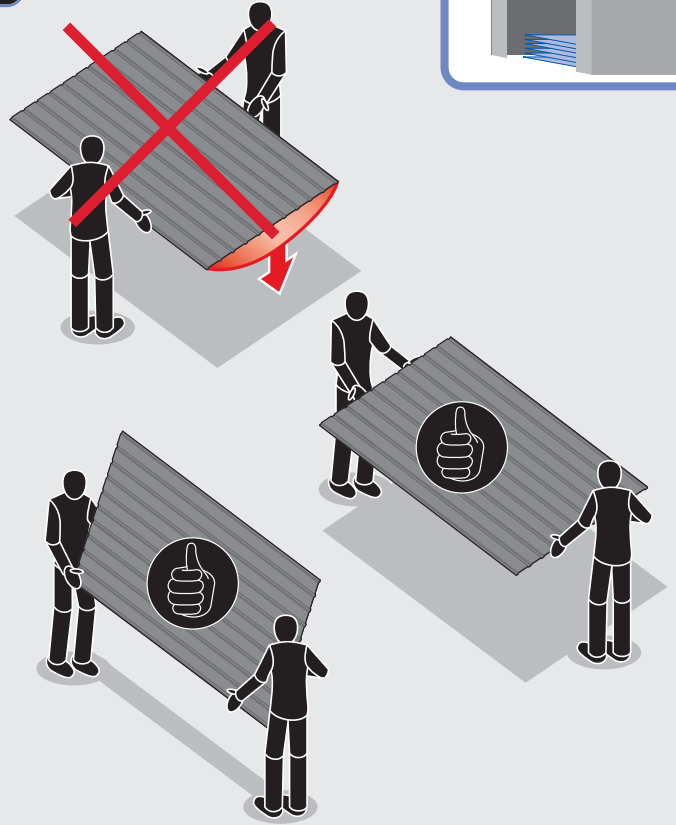

7

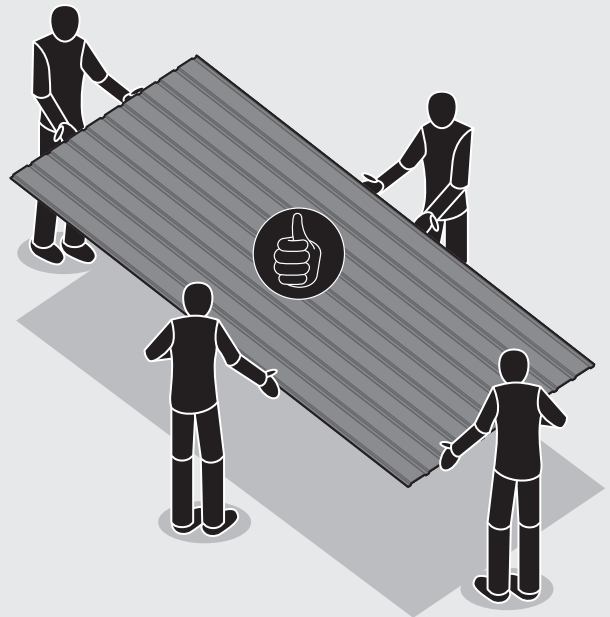
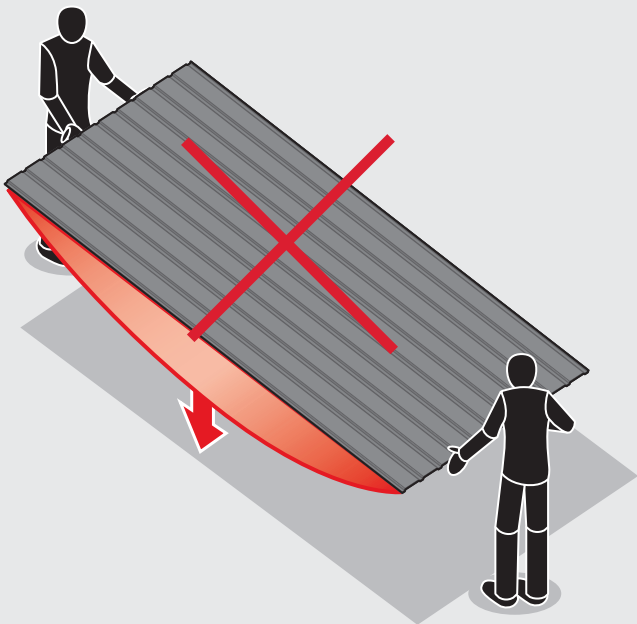



**BLACHOTRAPEZ Sp.z o.o.**  
**ul. Kilińskiego 49A**  
**34-700 RABKA ZDRÓJ, POLSKA**  
**tel. 18 26 85 200, fax. 18 26 85 215**  
**[www. blachotrapez.eu](http://www.blachotrapez.eu)**  
**[blachotrapez@blachotrapez.eu](mailto:blachotrapez@blachotrapez.eu)**